

Warrumbungle Shire Council Development Control Plan 2015



Table of Contents

1. INTRODUCTION.....	9
Name of Plan.....	9
Relationship with other plans.....	9
Purpose of the Plan.....	9
Interpretation of Legislative References.....	9
Relevant Local Environmental Plan.....	9
State Environmental Planning Policies (SEPPs).....	9
Building Code of Australia (BCA).....	10
Contributions.....	10
Variations to provisions.....	10
2. SUBMITTING AN APPLICATION.....	11
Is a Development Application required?.....	11
<i>Table 1 Development Categories.....</i>	<i>11</i>
Submitting a Development Application.....	12
Pre-Lodgement Meeting.....	12
DA forms and other documentation.....	12
BASIX.....	13
Construction Certificate (CC) Requirements.....	13
Statement of Environmental Effects.....	14
Application for Modification to a Development Consent (Section 8.23 Applications).....	14
Lodgement of a Review of Determination Section 8.3 Application.....	14
<i>Diagram 1 Development Application Process.....</i>	<i>15</i>
3. NOTIFICATION PROCEDURES.....	16
Purpose.....	16
Objectives.....	16
Notification Procedures and Guidelines for Applications.....	16
Notification of Applications.....	16
Statutory Obligations.....	16
Neighbour Notification and Public Advertising.....	17
<i>Table 2 Schedule of Notification and Advertising of Developments.....</i>	<i>18</i>
Notification.....	19
<i>Diagram 2 Notification Plan.....</i>	<i>19</i>
Criteria for Required Neighbour Notification.....	19
Form of Notice.....	20
Plans to Accompany Notice.....	20
Exhibition Period.....	20
Written Submissions.....	21
Council Must Consider Submissions.....	21

Council Meeting Policy (Public Forum)	21
Notification of Determination of Application – Person making Submissions	21
4. SUBDIVISION	22
Objectives	22
General Advice to Applicants for Subdivision.....	22
<i>Diagram 3 Concept Subdivision Plan</i>	23
Subdivision Requirements	23
<i>General</i>	23
<i>Landscaping</i>	24
<i>Utility Services</i>	24
<i>Vehicle Access</i>	24
<i>Alignment of existing public roads</i>	24
<i>Rights of carriageway</i>	25
<i>Construction and dedication of a Crown Road as a Council Public Road</i>	25
Land Zoned RU1 Primary Production and R5 Large Lot Residential	26
<i>General Requirements</i>	26
<i>Battle Axe Subdivisions</i>	26
<i>Wedged shaped lots</i>	26
<i>Side and rear setbacks for building envelopes in R5 Zones</i>	26
<i>Subdivisions involving the Opening of New Public Roads</i>	26
<i>Fencing</i>	27
Land Zoned RU5 Village and R1 General Residential	27
General Requirements	27
<i>Residential subdivision</i>	27
<i>Residential Infill Roadworks</i>	27
<i>Parks and reserves</i>	27
<i>Stormwater drainage</i>	28
Subdivisions involving the opening of a public road.....	28
<i>Roads</i>	28
<i>Table 3 Residential Roads</i>	28
<i>Footpaths</i>	28
<i>Street Lights</i>	29
<i>Water supply</i>	29
<i>Sewer mains</i>	29
<i>Non Sewered Areas</i>	29
<i>Electricity and Telecommunication Services</i>	29
<i>Easements</i>	29
Residential Release Areas Zones R1 and RU5	29
Objective	29
Structure Plan.....	30

Roads.....	30
Environment.....	30
Infrastructure.....	30
Land Zoned B2 Local Centre and IN1 General Industrial.....	30
Commercial subdivision and industrial subdivision.....	30
Table 4 Industrial Roads.....	31
Community Title Subdivision all Zones.....	31
5. OTHER DEVELOPMENT CONTROLS.....	32
Access and Parking.....	32
Objectives.....	32
Access and Traffic Generation.....	32
Parking Controls.....	32
Table 5 Off-Street Parking Rates.....	33
Bushfire Prone Land.....	36
Agritourism.....	37
Objectives.....	37
Controls.....	37
Location.....	37
Vegetation and landscaping.....	38
Hazards.....	39
Waste management.....	40
Biosecurity.....	40
Traffic, access and parking.....	41
Signage.....	42
Ongoing operations.....	43
Farm stay accommodation.....	43
Objectives.....	43
Farm gate premises and farm experience premises.....	45
Roadside stalls.....	46
Temporary occupation of a building during erection of a dwelling.....	47
Installation of manufactured home, moveable dwelling or associated structure.....	48
Purpose.....	48
Definitions.....	48
Need to lodge a Development Application (DA).....	48
Need for a Construction Certificate.....	49
BASIX.....	49
Other requirements.....	49
Other Specialist Reports.....	49
Development on Bush Fire Prone Land.....	49
Application package is to include (but not limited to).....	50

Contaminated Land	51
<i>Introduction</i>	51
Objectives	51
Controls.....	51
<i>What is Contamination?</i>	52
<i>Duty to report</i>	52
<i>Procedural principals</i>	53
<i>Procedures for Development Applications</i>	54
<i>Table 6 Contamination Table</i>	55
Outdoor Advertising Signage.....	58
Objectives	58
<i>Signs</i>	58
<i>Diagram 4 Street Signage</i>	59
<i>Prohibited Signs</i>	59
<i>Table 7 Prohibited Signs</i>	60
<i>Signage in heritage areas</i>	60
<i>Signage in business areas</i>	60
<i>Diagram 5 Displaying of Signs</i>	61
<i>Signage in industrial areas</i>	61
<i>Signage in residential areas</i>	61
<i>Signage in rural areas</i>	62
<i>Tourist signage Identification signs</i>	62
<i>Maintenance and illegal signs</i>	62
<i>Temporary signage</i>	62
Heritage Conservation.....	64
<i>Where this Section applies</i>	64
<i>Conservation</i>	64
<i>Building height and alignment</i>	64
<i>Building form</i>	65
<i>Roofs</i>	65
<i>Facades</i>	65
<i>Verandahs</i>	66
<i>Signage</i>	66
<i>Proposed signage controls</i>	67
Flood Prone Land.....	68
Objectives	68
<i>Decision guidelines</i>	69
<i>Flood Planning Area</i>	69
<i>Development Outside the Flood Planning Areas</i>	69
<i>Table 8 Flood Definitions</i>	70

<i>Table 9 Flood Categories and Development Requirements</i>	71
Sex Services Premises (Brothels)	77
<i>Location</i>	77
<i>Size and Layout</i>	77
<i>Car Parking</i>	77
<i>Signs</i>	77
<i>Security and Public Safety</i>	77
<i>General Requirements</i>	77
<i>Clause 6.7 Location of Sex Services Premises WLEP 2013</i>	78
<i>Limit on Development Consent</i>	78
6. RURAL DEVELOPMENT CONTROLS	79
Objectives	79
Requirements.....	79
<i>General Design Requirements</i>	79
<i>New buildings</i>	79
<i>Vehicle Access Requirements</i>	80
<i>Environmental Considerations</i>	80
<i>Bushfire Protection</i>	81
<i>Flooding</i>	81
<i>Land Use Separation</i>	81
<i>Table 10 Land Use Separation</i>	81
<i>Effluent Disposal (Domestic)</i>	82
<i>Electricity and Telecommunications Infrastructure</i>	82
<i>Water</i>	82
<i>Contamination</i>	83
<i>Fencing</i>	83
<i>Rural Workers Dwelling</i>	83
7. RESIDENTIAL DEVELOPMENT CONTROLS	85
Objectives	85
Dwelling Houses and Ancillary Structures in RU5 Village and R1 General Residential Zone	85
Requirements.....	85
<i>Building Height and Scale</i>	85
<i>Diagram 6 Building Height</i>	85
<i>Front and Rear Building Setbacks</i>	85
<i>Diagram 7 Building Setback</i>	86
<i>Articulation Zone within Front Building Set back</i>	86
<i>Vehicle Access</i>	86
<i>Car Parking</i>	87
<i>Outbuildings, Garages and Carports</i>	87

<i>Privacy</i>	87
<i>Design</i>	87
<i>Site Coverage</i>	87
<i>Roof Pitches</i>	87
<i>Retaining Walls</i>	87
<i>Water Storage Tanks</i>	87
<i>Fencing</i>	87
<i>Diagram 8 Front Fencing</i>	88
<i>Diagram 9 Solid Fencing</i>	89
<i>Swimming Pools</i>	89
Services	89
<i>Non Sewered Areas</i>	90
<i>Stormwater Drainage</i>	90
<i>Water Tanks</i>	90
Relocated Dwellings	90
Manufactured Homes and Moveable Dwellings	91
Affordable Rental Housing SEPP – Granny Flats and Secondary Dwellings	Error!
	Bookmark not defined.
Dual Occupancy and Multi-Dwelling Housing	91
<i>Requirements - Dual Occupancy</i>	91
<i>Requirements - Multi-Dwelling Housing</i>	91
General Requirements for Dual Occupancy and Multi-Dwelling Housing.....	92
<i>Building Height</i>	92
<i>Detached Dual Occupancy</i>	92
<i>Roof Pitches</i>	92
<i>Setbacks to Boundaries</i>	92
<i>Articulation Zone within Front Building Set back</i>	92
<i>Car Parking</i>	92
<i>Access</i>	92
<i>Footpaths</i>	93
<i>Carports and Garages</i>	93
<i>Solar Access</i>	93
<i>Street Design</i>	93
<i>Diagram 10 Street Frontage & Site Layout</i>	93
<i>Privacy and Amenity</i>	94
<i>Private Open Space</i>	94
<i>Diagram 11 Private Open Space</i>	Error! Bookmark not defined.
<i>Landscaping</i>	94
<i>Waste Management</i>	94
<i>Clothes Drying Facilities</i>	94

<i>Fencing</i>	94
<i>Letterboxes</i>	94
<i>Adaptable Housing</i>	95
<i>Stormwater Drainage</i>	95
<i>Utilities and Services</i>	95
<i>Non Sewered Areas</i>	95
Containers	95
8. COMMERCIAL DEVELOPMENT CONTROLS	96
Objectives	96
<i>Building Setbacks</i>	96
<i>Height</i>	96
<i>Outdoor lighting</i>	96
<i>Outdoor Signage</i>	96
<i>Design</i>	96
<i>Post supported verandahs and balconies</i>	97
<i>Utilities and Services</i>	97
<i>Traffic and Access</i>	97
<i>Parking</i>	98
Access for Persons living with a Disability	98
<i>Objectives</i>	98
<i>Controls</i>	98
<i>Change of Use of Use</i>	98
<i>Heritage Considerations</i>	98
9. INDUSTRIAL DEVELOPMENT CONTROLS	99
Objectives	99
Requirements	99
<i>Building Setbacks</i>	99
<i>Design</i>	99
<i>Utilities and Services</i>	99
<i>Landscaping</i>	99
<i>Fencing</i>	100
<i>Access</i>	100
<i>Parking</i>	100
<i>Loading/Unloading Facilities</i>	100
<i>Outdoor Signage</i>	100
<i>Outdoor Lighting</i>	100
<i>Noise</i>	101
<i>Industrial Development in RU5 Residential Village Zone</i>	101
10. DEFINITIONS.....	102
<i>Appendix A</i>	105

1. INTRODUCTION

Name of Plan

This plan is known as the Warrumbungle Development Control Plan (DCP) 2015. It applies to the Warrumbungle Local Government Area (LGA). It has been prepared in accordance with Section 74C of the Environmental Planning and Assessment Act 1979 (EP&A Act) and the Environmental Planning and Assessment Regulations 2000 (EP& A Regulations).

The DCP was adopted by Council on 17 September 2015 and commenced operation 23 February 2017 and subsequently amended on 16 February 2017 by Council Resolution 190/1617.

Relationship with other plans

The DCP should be read in conjunction with the Warrumbungle Local Environmental Plan 2013 and any relevant State and Regional Environmental Planning Policies, bearing in mind that a proposal may be affected by more than one chapter of this plan.

Prospective applicants are encouraged to discuss their development proposals at an early stage via Council's pre-lodgement advice service with relevant staff to ensure compliance with the requirements of the DCP and other relevant planning requirements.

Purpose of the Plan

The purpose of the plan is to support the broad objectives of the Warrumbungle Local Environmental Plan 2013 (WLEP 2013) by:

- a) Supporting the provisions of the WLEP 2013
- b) Providing clear and concise development guidelines for various forms of development
- c) Encouraging a high standard of development that respects and maintains the shires existing urban, rural and natural environment
- d) Outlining Councils development application submission and application notification requirements
- e) Guiding members of the public in the development process
- f) Expediting development approvals by providing clear direction on Councils intent and criteria in the development process
- g) Providing certainty of development outcomes for developers and the community.

Interpretation of Legislative References

Various references are made to legislation in this DCP. Legislation may include Acts, Regulations and Environmental Planning Instruments. Where such legislation changes during the currency of this DCP, reference in the DCP to the legislation should be taken as a reference to the most recent version of that legislation or as a reference to legislation that has replaced the referenced legislation. 'Hyperlinks' embedded into the digital version of the DCP will direct the reader to the relevant legislation. Alternatively, current NSW legislation can be found at www.legislation.nsw.gov.au.

Relevant Local Environmental Plan

The plan relates to Warrumbungle Local Environmental Plan 2013 (WLEP2013), as amended. In the event of any conflict between this DCP and that Plan, WLEP 2013 takes precedence. The WLEP 2013 is found on Council's website www.warrumbungle.nsw.gov.au

State Environmental Planning Policies (SEPPs)

SEPPs apply to certain development that involves matters or issues of relevance to the State. The full list of SEPPs is found at the NSW Planning and Infrastructure website

www.planning.nsw.gov.au

Building Code of Australia (BCA)

The BCA applies for all building construction works. Irrespective of any other control in this document, the requirements of the BCA will take precedence.

Contributions

Where a development will, or is likely to, increase the demand for public services and amenities, Council may require a contribution towards the cost of providing those services and facilities. Under Councils Section 7.12 Contribution Plan 2021, contributions may be required towards community facilities identified in the plan. Where a levy amount is required it will be included as a condition of consent.

Variations to provisions

Council acknowledges that it is not possible to account for all possible situations, sites and development scenarios. Consequently, when circumstances warrant, Council may consent to an application which departs to a minor extent, from the provisions of the plan. In such cases, a written submission must be lodged with the development application.

Any written request for a departure must include:

- A description of the requirement to which a departure is sought
- A description of the reasons why the departure is being sought; and
- Justification of how the proposal meets the aims, objectives and intent of the standard.

A proforma form is available from Council or on its website www.warrumbungle.nsw.gov.au to assist in preparing your written request for variation for submission with the development application.

2. SUBMITTING AN APPLICATION

Is a Development Application required?

Development includes the use of land or premises, the change of use of a building, advertising signage, subdivision of land, the erection of a building, the carrying out of work (e.g. earthworks, landfill) and the demolition of a building.

The first step in undertaking a development is to determine if it is a permissible use and if it requires a Development Application (DA).

Table 1 below details the different categories of development and whether a Development Application is required or whether a Complying Development Certificate (CDC) application may be obtained.

Table 1 Development Categories

Type of Development	Description	Development Consent Required
Development that does not require development consent		
Exempt Development	Exempt development is development of minimal environmental impact. State Environmental Planning Policy (Exempt and Complying Development Codes) 2008 (the Codes SEPP) specifies exempt development under that Policy. The Code SEPP has state wide application and commenced on 27 February 2009. A copy of the SEPP is available at: http://www.legislation.nsw.gov.au http://www.planning.nsw.gov.au/housingcode	No DA required
Development that required consent		
'Only with Development Consent'	If a type of development is identified under the heading 'Only with Development consent' for a particular zone within the Land Use tables of the Warrumbungle LEP 2013, a Development Application will need to be lodged and determined by Council.	Yes. DA required
Complying Development	Certain common and routine developments that do not require a merit assessment as long as it complies with specified, predetermined development standards. Complying development may be certified by either Council or a private certifier. A merit assessment is undertaken for complying development. It is required to be notified	Yes. A Complying Development Certificate is required
Major Project Development	State Environmental Planning Policy (Exempt and Complying Development Codes) 2008 (the Codes SEPP) specifies complying development under that policy. The Minister has declared that certain developments are of state significance. Developments falling under this category will be rare in Warrumbungle LGA.	DA required (The Minister is the consent authority).

Development that requires additional issues to be covered as part of the consent process

Integrated Development	Some proposals not only require development consent for Council but also a permit or license from a state government agency or other approval authority. In such cases, Council will refer the application to the necessary agency so that there is an integrated assessment for the proposal. If the development is approved, the terms of any additional approvals or licences will be incorporated into the approval	Yes, DA required
	The Council must not impose any conditions which are inconsistent with those indicated by the other approval authority. If the approval authority indicates that it will not grant approval the Council must refuse the development consent.	
Designated Development	Designated development is defined in Schedule 3 of the Environmental Planning and Assessment Regulation 2000. This schedule lists those developments where a more rigorous environmental impact assessment process is necessary. These applications require the preparation of an Environmental Impact Statement (EIS) which must be undertaken in accordance with the requirements of the Director – General of the NSW Department of Planning.	Yes, DA required and EIS

Submitting a Development Application

The WLEP 2013 establishes whether Development Consent, a Construction Certificate or a Complying Development Certificate is required for proposed development or works. The relevant application must be made to obtain consent. Applicants are advised to refer to the WLEP 2013, or contact Council’s Development Services to confirm consent requirements.

All applications must be lodged via the NSW Planning Portal.

Pre-Lodgement Meeting

Before lodging an application via the NSW Planning Portal, it is strongly recommended that the applicant organise a pre-lodgement meeting with Council Officers to discuss the proposal and obtain feedback on the likely issues that need to be addressed by the application. Council Officers cannot guarantee a favourable outcome for any development application at pre-lodgement stage, and such outcomes can only be determined following submission of all relevant information, plans, fees and completion of the assessment process.

The development application process is outlined in Diagram 1.

DA forms and other documentation

The minimum information required for all Development Applications:

- a) A completed Development Application on the NSW Planning Portal
- b) Written owners consent (all landowners signatures or in the case of a company the company seal and authorised persons signature;
- c) Statement of Environmental Effects;
- d) Prescribed fees;
- e) Site plan including road, utility services, easements and boundary setbacks;
- f) Site analysis plan for larger developments. This is expressed in the form of a sketch drawing (site analysis plan) of the subject site and adjoining land which accurately identifies and explains:
 - i) Key features of site (buildings and their setbacks, site dimensions, area, spot levels and contours, easements, location of services, trees and the like),

- ii) How the development relates to those features and immediate surroundings.
- g) Survey Plan with site levels (in some cases);
- h) Scaled drawings detailing;
 - i) Floor plans;
 - ii) Elevations;
 - iii) Finished levels;
 - iv) Vehicle access and parking arrangements;
 - v) Landscaping;
 - vi) Proposed methods of drainage;
 - vii) Shadow diagram for dwellings over single storey in RU5 and R1 zones where potential shadow impacts may occur to neighbours;

Depending on the type of development other information may be required:

- Bushfire Assessment Report;
- Preliminary flora and fauna assessment (7-part test under the Threatened Species Conservation Act 1995);
- BASIX Certificate and commitments shown on plans (see next heading);
- Engineering investigation report for flood affected land;
- Flood Prone Land – Floor and Ground Levels (AHD);
- On-Site Sewage Management System (OSSMS) application (may require supporting Geotechnical and Water Balance reports);
- Water Supply Connection Application Form;
- Heritage Impact Statement;
- Aboriginal Heritage Assessment;
- Traffic Study;
- Contamination Report (Preliminary or Detailed Investigation);
- Acoustic Report;
- List of existing and proposed fire safety measures;
- Environmental Impact Statement (for designated development);
- Submission of a Section 68 Application for approval under Local Government Act 1993. As advised by Council's Development Services Staff;
- Soil type/classification.
- Water and sewer access connection forms for new development
- Liquid Trade Waste application form

BASIX

The BASIX State Environmental Planning Policy (SEPP) which commenced on 1 July 2004 aims to ensure consistency in the implementation of the BASIX scheme throughout the State by overriding provisions of development control plans that would otherwise add to, subtract from or modify any obligations arising under the BASIX scheme. The BASIX assessment tool assesses residential development by looking at the three components of sustainable building design being water use, greenhouse gas emissions due to energy consumption and thermal comfort.

The BASIX web site identifies whether your development proposal requires a BASIX certificate (see www.basix.nsw.gov.au)

Construction Certificate (CC) Requirements

The following details will need to be submitted with the CC:

- a) Plans and Specifications;
- b) Plans showing the Bushfire requirements (if applicable);
- c) Structural Engineers Report/Slab/Footing details;
- d) Engineers Framework/Bracing/Tie Down details;
- e) Storm water drainage details;

- f) Builder/Owner builder details;
- g) Soil type/classification.

For further guidance on DA and CC information requirements contact Council's Environment and Development Services.

Statement of Environmental Effects

A Statement of Environmental Effects (SEE) must accompany all development applications. The SEE must demonstrate that the environmental impact of the development has been addressed and sets out the steps to be taken to protect or to mitigate harm to the environment. The SEE must demonstrate how the development satisfies the relevant policies in the DCP and justify any non-compliance.

For minor developments (carport, pergolas, dwellings, alterations etc.) the applicants must complete Council's SEE form 1. For larger scale developments Council's SEE form 2 should be completed.

Both SEE forms are available from Council and can be found on Council's website www.warrumbungle.nsw.gov.au.

Application for Modification to a Development Consent (Section 8.23 Applications)

An application for a modification to development consent under Section 8.23 of the Environmental Planning and Assessment Act 1979 must be accompanied by the following information (as a minimum):

- a) A completed application form (including owners consent) and prescribed fee;
- b) A statement outlining the proposed modification/s and identifying the relevant conditions of consent that are to be amended;
- c) Plans highlighting the proposed modification (coloured or clouded);
- d) A statement addressing the potential impacts of the proposed modification/s;
- e) Proposed wording of amended conditions.

A modification application may need to be notified or advertised in the same manner as the original application.

Lodgement of a Review of Determination Section 8.3 Application

A Section 8.3 Review of Determination application may be lodged with Council if an applicant is dissatisfied with Council's original decision on the application. A Section 8.3 application must be lodged with Council within 12 months of the date of the determination of the original application. The Section 8.3 application must be accompanied by the prescribed fees under the Environmental Planning and Assessment Act 1979.

A Section 8.3 application may make amendments to the proposed development provided it remains substantially the same development as described in the original application. Where the previous application was notified the application will be publicly notified in the same manner as the original application but for a maximum period of 14 days. Where the determination of the original application was made by Council, the application will be resubmitted to Council for its determination, pursuant to sub-section 8.3 (6) of the Environmental Planning and Assessment Act 1979.

Diagram 1 Development Application Process

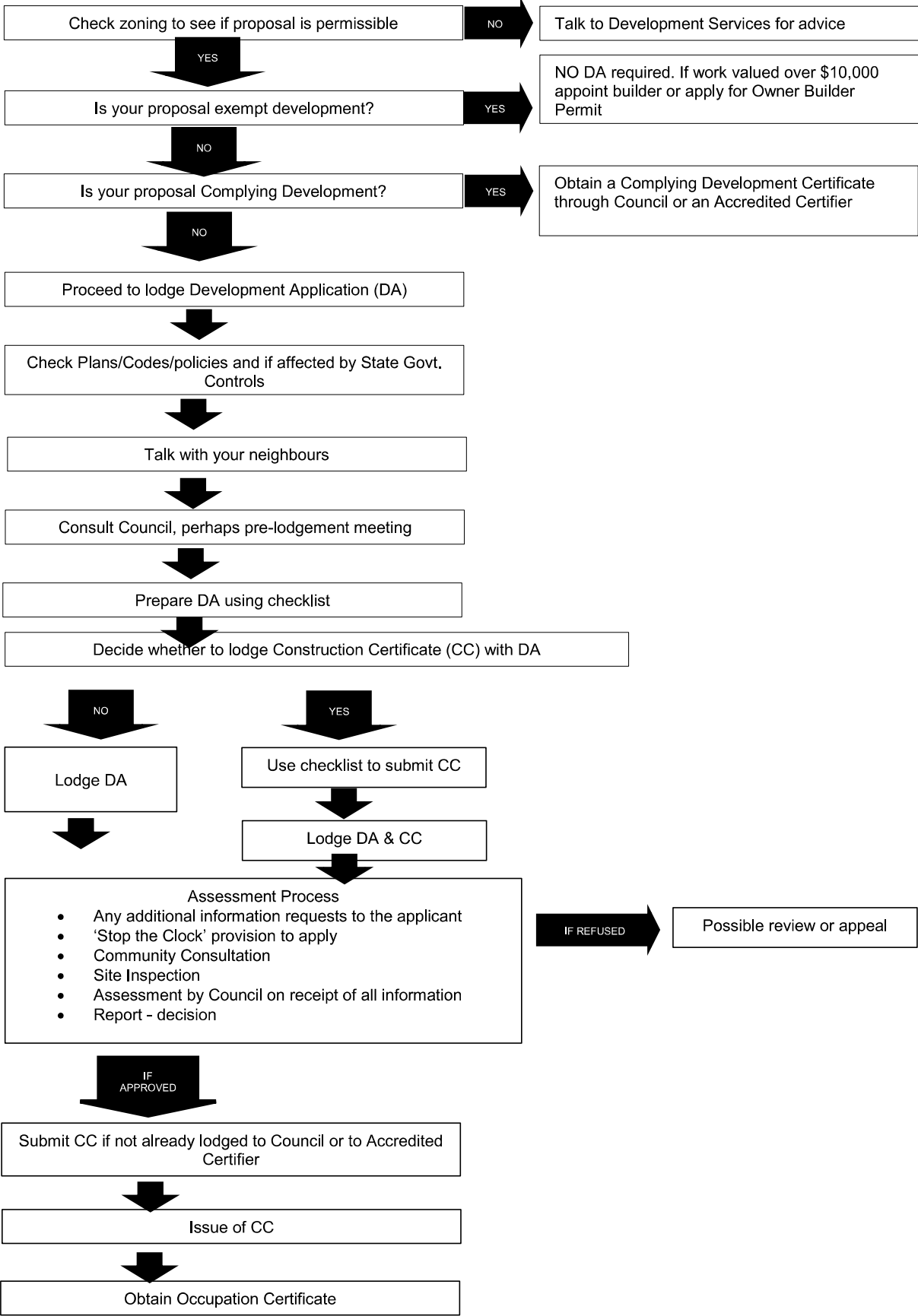

3. NOTIFICATION PROCEDURES

Purpose

This section of the DCP outlines Council's policy for community notification in the assessment of development applications and the formulation of development guidelines and policies. The Section also outlines the necessary procedures involved in carrying out such notification.

Objectives

- Clearly state Council's requirements for the notification of development applications and formulation of guidelines and policy.
- Provide for public participation in the DA process for certain development proposals.
- Allow for a reasonable time for inspection and making submission on applications while recognizing the obligations of the Council to determine applications within prescribed periods.
- Provide a direct avenue of access to the application process by affected residents and owners who wish to express their concerns about proposals to Council.
- Explain matters for which the Council will have regard when forming its opinion as to whether or not the enjoyment of adjoining land may be detrimentally affected by a proposed development.
- Specify the circumstances when notification is not required.
- Detail the form that notification will take and an applicant's responsibility to provide a notification plan.

Notification Procedures and Guidelines for Applications

This section provides detailed guidelines on procedural processes that must be followed when notifying the community of applications. This plan provides for two levels of public consultation that an application may be subject to. These are **neighbour notification** and **newspaper advertising**. All newspaper advertising will also be placed on Council's web site.

Notification of Applications

Adjoining landowners will be given notice of an application if, in the opinion of Council, land adjoining the development may be detrimentally affected by a development proposal. The following issues will be considered in the assessment and determination of a development:

- Views to and from the land;
- Overshadowing;
- Privacy and amenity;
- Noise, odour, dust, light spill or other polluting emissions;
- Proposed hours of use for the development;
- The scale or bulk of the proposed development;
- The positioning of the development in relation to site boundaries.

Statutory Obligations

Council has certain obligations under the Local government Act 1993 and the Environmental Planning and Assessment Act 1979 (EPA Act) to notify owners of land whose enjoyment of that land may be affected by the proposed development. A notification and advertising fee will be charged to the applicant by Council at lodgement of the Development Application.

Certain categories of development (i.e. Designated Development, State Significant Development, Integrated Development and Advertised Development) are required to be exhibited in accordance with the procedures for notification prescribed by the EPA Act and Regulations.

Neighbour Notification and Public Advertising

Neighbour notification and public advertising shall be in accordance with the following:

Development that will not be notified

Council **will not notify or advertise** applications for the following development types except where Council deems necessary:

- Exempt Development;
- Detached single storey dwelling in RU5, R1, R5 and RU1 that are compliant with this DCP;
- The following ancillary structure and alterations:
 - Ancillary structures associated with single storey dwellings including single carports, pergolas, garden sheds, and the like, which are sited 1 metre from any boundary, sited behind or in-line with the existing building line and side boundary setbacks and comply with Council's building setbacks in this plan excluding swimming pools;
 - Alterations to an existing single storey dwelling where the works will not result in any change of height and are sited behind or in-line with the existing building line of the existing building;
 - Ancillary structures associated with multi-dwelling housing including carports, garages, pergolas, garden sheds and the like which are sited 1 metre from any boundary, sited behind or in-line with the existing building line and comply with Council's building setbacks;
 - Alterations associated with multi-dwelling housing where the works will not result in any change of height, external configuration or external facade of the existing building sited behind or in-line with the existing building line and comply with Council's building setbacks.
- Subdivisions:
 - For boundary adjustments or consolidation of not more than two (2) allotments to one (1);
 - For strata title purposes.
- Rural sheds, outbuildings and ancillary farm structures in R5 and RU1 Zones that comply with this DCP;
- Commercial or Industrial development within B2, B6 and IN1 zones (except the demolition of a State or local heritage item);
- Applications for internal alterations and renovations for any building in any zone where the works are non-structural and are contained entirely within the existing building envelope including recladding of buildings, replacement of windows and doors;
- Any other development considered by Council or its Delegated Officers as having low impact on the environment, to adjoining neighbours or the locality.

Development that will be Notified and Advertised

A development application shall be notified, advertised and be available for inspection for the periods as specified in Table 2 overleaf:

Table 2 Schedule of Notification and Advertising of Developments

Development Type	Exhibition Period	Written Neighbour Notify	Newspaper Advertising and Councils web site
Dwelling house comprising 2 or more storeys in RU5 and R1	14 days	Yes	No
Dual occupancies (attached or detached) in RU5 and R1	14 days	Yes	No
Attached dwellings and semi-detached dwellings	14 days	Yes	No
Multi dwelling housing	14 days	Yes	Yes
Residential flat buildings	14 days	Yes	Yes
Seniors housing	14 days	Yes	Yes
Hostels and Boarding houses	14 days	Yes	Yes
Shop top housing	14 days	Yes	Yes
Manufactured or relocated dwellings in RU5 and R1	14 days	Yes	No
Restricted Premises	14 days	Yes	Yes
Tourist and visitor accommodation in urban areas *	14 days	Yes	Yes
Non-residential development in or adjoining the RU5, R1 and R5 zone	14 days	Yes	Yes
Demolition of a Heritage Item	14 days	Yes	Yes
Subdivision involving the creation of new additional allotments	14 days	Yes	Yes - if an additional 5 or more lots are created
Major projects (not including utility services infrastructure) with a value exceeding \$1 million or likely to be of significant community interest	14 days	Yes	Yes – if appropriate
Any development (<i>including change of use</i>) which in the opinion of the Council or its delegated staff may have potential for adverse impacts on the general amenity of a locality including views to or from an adjoining property or other perceived impacts.**	14 days	Yes	Yes – if appropriate

*tourist and visitor accommodation in urban areas – newspaper advertisement is not required for bed and breakfast accommodation, or minor alterations and additions to existing tourist and visitor accommodation.

**Does not include Designated, Integrated and Advertised Development or State Significant Development. The length of notification period varies and will be accordance with the Environmental Planning and Assessment Regulation 2000 unless a longer period is determined by Council.

Notification

Development referred to above will be notified in the following ways:

- Those persons who own land or occupiers of land either adjoining the side and rear boundaries, or adjacent to the subject land or as may potentially be affected by the subject development (see Diagram 2 below). All affected persons will be notified in accordance with the provisions of this chapter.
- An Association for a community, precinct or neighbourhood parcel within the meaning of the “Strata Schemes (Leasehold Development) Act 1986” and the “Strata Schemes (Freehold Development) Act 1973”
- If, in the opinion of Council or its delegated officers, the enjoyment of any other land may be affected by the proposed development:
 - The owners of such other land
 - The owners of land separated only by a pathway, driveway or similar thoroughfare from the proposed development
- Certain development applications require notification and/or referral to other government authorities. Notice may also be given to an adjoining Council, if the proposal is in close proximity to the LGA boundary and it may have potential impacts for that Council.

Diagram 2 Notification Plan

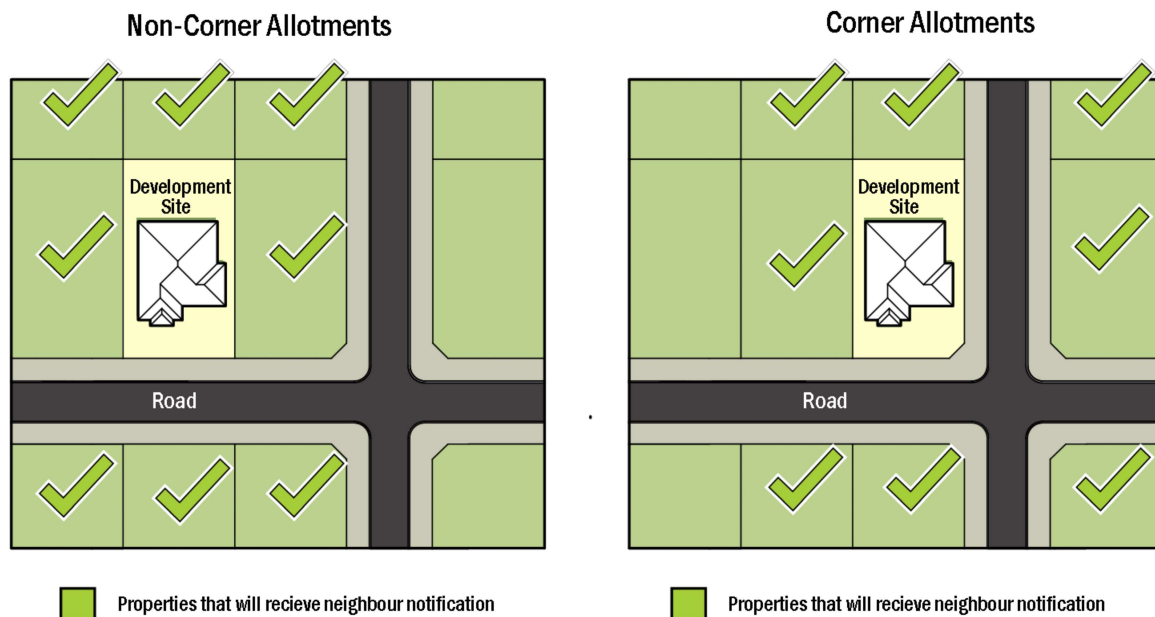

Criteria for Required Neighbour Notification

The extent of neighbour notification will be determined having regard to the following:

- The siting of the building and its proximity to boundaries
- The design of the building, and in particular its height, bulk and scale and its relationship to the character of existing development in the vicinity and the streetscape
- The use of proposed rooms and the possible effect on adjoining land due to overlooking and loss of privacy
- The views to and from adjoining land
- Any overshadowing of adjoining land
- Natural drainage of the site, and possible changes in response to the proposed works and the impacts that this may have on adjoining properties
- The likelihood of the adjoining land being detrimentally affected by noise or other

potential nuisance.

Form of Notice

Written notice shall contain the following information:

- The property description or address of the site affected by the application
- A description of the specific development for which approval is being sought
- The name of the applicant
- An invitation to inspect the application
- Details of where the application can be inspected
- A statement that any person may make a submission in writing
- The time within which written submissions will be received.

Advice that:

- The information within a written submission may be included in a report to Council
- Council is subject to the Government Information (Public Access) Act 2009 legislation and that copies of written submissions may be made available to any persons entitled to lodge an application under this legislation. Submitters names and other private details will be withheld.

Plans to Accompany Notice

Notice of a development application must be accompanied by plans of the proposed development, in an approved form, showing the height and external configuration of the building/structure in relation to the site on which it is proposed to be erected. Such plans must:

- Be clearly drawn to a scale of 1:100 (min), or to the satisfaction of Council
- Include all elevations sufficient to delineate the development
- Include a site plan showing the relationship of the proposed building to the boundaries of the allotment
- Be clearly dimensioned to indicate size, height and position of building
- Indicate the levels of floors, ceilings and ridges in relation to the levels of the site and accurate ground levels adjacent to the elevations of the building being shown if required
- Shadow diagram for residential buildings of two storey
- Include any other information Council, or its delegated officer, considers appropriate

Should the form of plan and details described be inappropriate to the circumstances of the case of the proposal the plan shall be in a form approved by Council staff with the appropriate delegations.

Exhibition Period

An application shall be available for inspection from the date of notice of the application for a minimum period of fourteen (14) calendar days (plus an additional 7 calendar days of exhibition where the period coincides with school holidays or additional day/s for public holidays).

During the exhibition period, any person may inspect, free of charge, during the ordinary office hours of Council, an application which has been notified whether or not that person has been, or is entitled to be, given notice under the provision of this policy.

Extracts of a development application relating to the erection of a building will be made available, upon request, to interested persons free of charge. This information shall include:

- Details of the applicant and the land to which the application relates, and

- A plan of the building that indicates its height and external configuration, as erected, in relation to the site on which it is to be erected.

Note: Residential floor plans are not available under the Privacy Act. All other information submitted with the application, including supplementary information, is available for the cost of reproduction, according to Council's current schedule of fees and charges. Reproduction may include photocopying or provision of an electrical copy of the material.

Written Submissions

Submissions in respect of an application must be received by Council within the date on the notice relating to the application. Additional period may be determined by Councils delegated staff in some circumstances.

A submission may be made by any person whether or not that person has been, or is entitled to be, given notice under the provision of this Policy.

Submissions must be made in writing and, if by way of objection, must state the reasons for the objection. All submissions must be addressed to the General Manger.

All written submissions received by Council will be acknowledged in writing.

Where the application is referred to Council for determination, submitters will be invited to address Council through the Public Forum at the Ordinary Meeting of Council (see below).

Council Must Consider Submissions

In determining applications, Council and/or delegated officers of Council, must consider all submissions under the provisions of this plan, before the application is determined.

Council Meeting Policy (Public Forum)

If the development is to be considered by the Council at a Council meeting, representations regarding the development may be made by interested members of the public at the meeting. Council's policy with respect to Public Forum guidelines can be found on Council's website www.warrumbungle.nsw.gov.au

Where a development is referred to Council for determination Council will notify submitters in writing of the date and time of the Council Meeting.

Notification of Determination of Application – Person making Submissions

Any person who makes a submission in relation to an application will be notified, in writing, of Council's decision.

4. SUBDIVISION

This chapter applies to rural, residential, commercial and industrial zones under WLEP 2013.

Objectives

- To ensure subdivisions are well integrated into the Shire's established or committed subdivision patterns.
- To provide lots with appropriate areas and boundary dimensions which take into account site constraints.
- To ensure the coordinated and cost-effective development of new residential areas.
- To encourage variety and choice in housing forms by providing lots for a broad range of lot sizes.
- To minimise adverse impacts on the natural and built environments and to ensure lots have appropriate levels of amenity, services and access.
- To achieve efficient use of land.
- To ensure rural lands are not fragmented in a manner that threatens their future use for agriculture or primary production.

General Advice to Applicants for Subdivision

- Prior to preparation of a Development Application, owners/applicants should contact Council's Development Services to:
 - discuss land zoning and any restrictions on the land (such as bush fire hazard or flooding); and/or
 - arrange a DA pre-lodgement meeting to discuss the particular site requirements that will need to be addressed prior to lodgement of the Development Application.
- Prepare a Conceptual Plan of Subdivision drawn to an appropriate scale (Refer to Diagram 3). It is recommended that the Plan of Subdivision be drawn by a surveyor (as this will be required anyway before issue of a subdivision certificate prior to finalization of the subdivision), however a less formal drawing may be acceptable for Development Application purposes provided it includes the following information:
 - property boundaries of the development site and adjoining land
 - contours
 - location of existing built and natural items on or adjacent to the land (e.g., buildings, roads, sewer, town water, electricity, telephone, trees, watercourse, dams, depressions, rock outcrops etc.)
 - location of all existing drainage reserves, easements and rights of way affecting or likely to affect the land
 - the proposed new lots and any new roads showing accurate dimensions and areas
 - proposed names for new roads
 - stormwater design and appropriate easements for drainage; and servicing
 - vehicle access points
 - existing easements
 - proposed building envelopes shown clear of any bushfire asset Protection Zones (APZ's), flooding and terrestrial biodiversity areas and slopes over 15%.
 - the building envelopes should allow for adequate on-site area and allow for the following buffer distances for on site management of waste water:
 - 100m to permanent surface waters (eg rivers, streams etc)
 - 250m to domestic groundwater well (where used as water supply) and 50m minimum to bore.
 - 40m to other waters (eg farm dams, intermittent waterways, drainage channels etc)
 - location of adjoining or nearby agriculture activities that may cause potential for

conflict (Refer to Table 5 Page 35)

Diagram 3 Concept Subdivision Plan

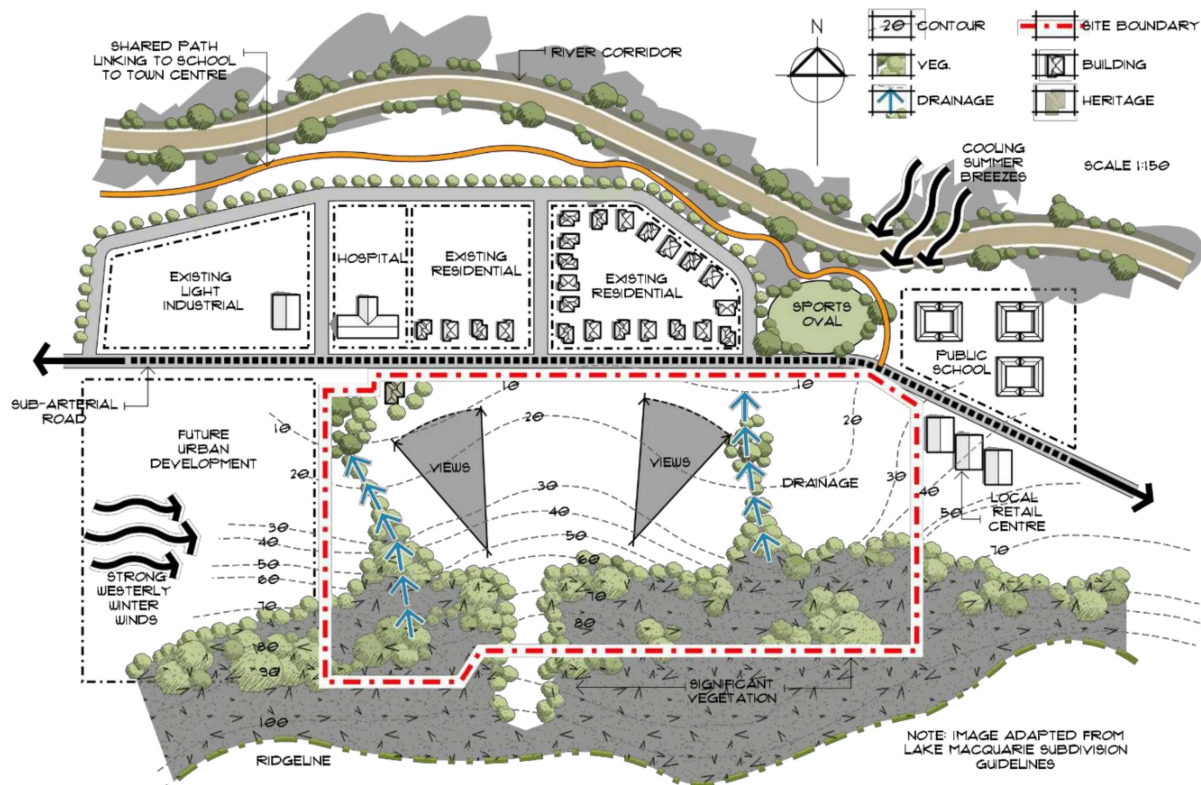

- All prominent hilltops and ridges are to be preserved from major infrastructure disturbances. Subdivisions should be designed so as to:
 - exclude roads, power lines and other services and amenities from significant hilltops,
 - exclude dams and other earthworks from hilltops,
 - any tanks and similar structures which are dependent upon gravity for their operation should be designed and located so as to blend in with the natural environment.

Subdivision Requirements

The following requirements will apply to subdivisions in all rural and residential zones.:

General

- The Lot Size Map and Clause 4.1 of the WLEP 2013 prescribes the minimum lot sizes for all new lots
- The lots have adequate frontage to depth ratio to enable satisfactory siting of future structures and supporting infrastructure.
- Public road upgrading and new roads created by subdivision shall be constructed in accordance with Council's standard adapted design guidelines. All construction costs associated with the development are to be met by the developer
- *Traffic Generating Development* (Schedule 3 of State Environmental Planning Policy Transport and Infrastructure 2021) will be referred to the Transport for NSW (tfNSW) as Integrated Development and will require their General Terms of Approval
- Development within bushfire prone land must meet the relevant requirements of the NSW Rural Fire Service and *Planning for Bushfire Protection 2019* and will require a

- report from a Bushfire Consultant.
- Development shall not be carried out on slopes greater than 15%. A geotechnical report may be required when subdividing steep land.
- Where subdivision is proposed to be carried out in stages, information is to be supplied detailing the staged release of lots and all infrastructure works (roads, water, sewer and stormwater drainage)
- Demonstrated consideration of whether the land to be subdivided is suitable for the intended purposes in accordance with *State Environmental Planning Policy (Resilience and Hazards) 2021*.
- All lots in new subdivisions in the RU1, E3 and R5 Zones will be allocated a new rural address number as part of the development consent. The applicant will be required to ensure the rural address number plate is installed for each lot prior to release of the Subdivision Certificate

Landscaping

- New subdivisions in the Zones R1, RU5, and IN1 must provide grass cover on verges.
- Street tree planting to be carried out in accordance with Council's Street Tree Policy.
- Security bonding for landscape works may be required by Council as a condition of consent.
- A basic landscaping plan showing intended location, type and mature height of trees is required to be submitted with a development application for subdivision
- Street trees must be located so as not to interfere with sight lines from driveways or the location of existing and future utility services

Utility Services

- All newly created lots in Zones R1, R5, RU5, RU1, B2 and IN1 are to be supplied with reticulated electricity and telecommunication services.
- Proposed alternative methods of power supply will be considered by Council for subdivision in RU1 Primary Production Zone and R5 Large Lot Residential Zone where the development is more than 1 km from the grid system or the cost to provide electricity exceeds \$30,000.00 per lot subject to a covenant being imposed on the land title stating that the provision of electricity to the allotment is to be provided by the landowner. The approval of alternative methods is at the discretion of Council.

Vehicle Access

- All new lots created by a subdivision must have legal and properly constructed access at the applicants cost. Depending on the circumstances, the following options are available for providing access:
 - a) Public Road as defined under the Roads Act 1993
 - b) Construction and dedication of a Crown Road as a Council public road
- Conflict with arterial and distributor roads is to be avoided. Direct access to a classified road will not be permitted where another practical option exists
- Where the subdivision proposes access to a classified road, the access will require concurrence from the Transport for NSW, and must be located and constructed in accordance with the relevant road authority requirements at the applicants cost
- Multiple vehicle access points to a property are not encouraged except where alternative access ways are required for bushfire protection mitigation measures.

Alignment of existing public roads

- Where the survey carried out for a subdivision determines that an existing public road passing through the land is located outside the road reserve, the submitted title plan shall make provision for widening of the road reserve to accommodate the road and associated drainage and infrastructure

Rights of carriageway

- Accesses by rights of carriageway are not supported by Council within rural zones except for battle axe subdivisions in R5 Zone -.

Construction and dedication of a Crown Road as a Council Public Road

An applicant wishing to construct a Crown road is required to obtain Councils concurrence to the ownership of the road being transferred to the Council, in terms of the Roads Act, 1993. This concurrence will be attached with the application to NSW Trade and Investment, Crown Lands.

Where Crown Lands concurs with the construction of the road, action will be taken by Council to transfer the ownership of the road to Council under the Roads Act. Council will then set the standards for road construction and any other requirements on the basis that Council will become the Roads Authority for the road.

All costs associated with the legal transfer of the road and the road construction works will be borne by the proponent.

The dedication of the road as public road does not imply Council will maintain the road following its construction.

Where the applicant cannot obtain the concurrence by Council to transfer the ownership the application for road construction will not be accepted and Crown Lands will not authorise construction (i.e. the application will be refused)

The Crown Lands authority does not support the development of Crown roads for new or more intensively used access to private property unless arrangements to transfer such road to Council are proposed.

Refer to Fact Sheet publication *Development and Crown Land by NSW Govt. Land and Property Management (LPMA), Crown Lands 2010* found on website www.lpma.nsw.gov.au

A formal resolution from Council is required for a Crown road to be transferred to Council under the Roads Act 1993 to enable its construction and dedication. The dedication of Crown Roads as public roads will not generally be supported by Council.

Where Council agrees to transfer the road under the Roads Act 1993 the following road construction standards will need to be met by the proponent at their cost:

- In the case of access to a single lot or where vehicle movements are likely to be less than 10 per day on average:
 - Gravel pavement width – 4 metres
 - Depth of compacted gravel – 100mm
 - Longitudinal grades greater than 1 in 6 are bitumen sealed
 - Drainage pipes installed to convey 1 in 10 year storm event
 - Adequate scour protection and table drains are constructed
- In the case of access to multiple lots or where vehicle movements are likely to be between 10 and 50 vehicles per day on average:
 - Gravel pavement width – 6 metres
 - Depth of compacted gravel – 200mm
 - Road grades, horizontal and vertical curves designed for a design speed of 60kph
 - Longitudinal grades greater than 1 in 6 are bitumen sealed
 - Drainage pipes installed to convey 1 in 10-year storm event

- Adequate scour protection and table drains are constructed
- Preparation of road construction plans

The following section applies to residential and rural subdivision

Land Zoned RU1 Primary Production and R5 Large Lot Residential

General Requirements

- All allotments shall connect with a formed roadway or have a road constructed in accordance with the requirements below.
- Access to any allotment created is to be at the expense of the applicant; constructed prior to release of the subdivision certificate being given, and to the standard required by the Director Technical Services

Battle Axe Subdivisions

A battle axe subdivision will only be considered involving a maximum of two (2) rural lots where:

- The access handle is at least 15 metres width for each lot and maximum distance of 200m.
- Each axe handle is to be constructed with a 4-metre gravel pavement with compacted gravel depth 100mm to enable all weather access to the lots;
- A shared constructed all weather access way with a reciprocal right-of-carriageway may be provided as an alternative.

Wedged shaped lots

Wedge shaped lots should be kept to a minimum in R5 zones. Where provided they should be at least 15m at the frontage and achieve a minimum width of 100m a maximum distance of 100m from the new lot boundary.

Side and rear setbacks for building envelopes in R5 Zones

In R5 Zones building envelopes should be designed to provide minimum 15m setbacks to side and rear boundaries for lot sizes 2ha - 4ha and minimum 25m for side and rear setbacks for lot sizes greater than 4ha.

Subdivisions involving the Opening of New Public Roads

Road Works

- The acceptance of land for dedication is a matter for Council to consider on merit
- All new rural roads are to be designed and constructed in accordance with standards set out in Austroads publications and in accordance with the following general principles:
 - **In R5 zones**
 - Road reserve width of at least 20 metres;
 - Road formation width of 8 metres, with widening at bends in accordance with Austroads guidelines. Road grades, horizontal and vertical curves designed for a design speed of 60kph;
 - Two coat bitumen seal applied to road surface;
 - Road pavement constructed to a depth of at least 200mm and with a road base product approved by Council and subject to assessment of subgrade conditions by a competent road pavement engineer;
 - Pipe culverts or concrete causeways where drainage across the road is required and designed to 1 in 10 ARI standard;
 - Adequate scour protection for roadside drainage and table drains shall

- be provided at least 300mm below the edge of the constructed road;
- Cul-de-sac radius of 9 metres.
- **In RU1 Zones**
 - Road reserve width of at least 20 metres
 - Road formation width of 6 metres (8 metres where connected to 8metre width road) with widening at bends in accordance with Austroads guidelines. Road grades, horizontal and vertical curves designed for a design speed of 60kph
 - Gravel surface – if the current access road has a gravel access
 - Sealed surface – if the current access road is a sealed road
 - Road pavement construction to a depth of at least 200mm with a road base product approved by Council and subject to assessment of subgrade conditions by a competent road pavement engineer.
 - Cul-de-sac diameter of 18 metres
 - Pipe culvert or concrete causeways where drainage across the road is required and designed to 1 in 10-year ARI standard
 - Adequate scour protection for roadside drainage and table drains shall be provided 300mm below the edge of the constructed road

Fencing

Stock proof fencing is to be provided at the applicants cost to all road frontages, public open spaces and along all new lots fronting the proposed road.

The applicant will also be responsible for constructing stock proof internal fencing along the boundaries for all new lots in RU1 and R5 Zones.

Land Zoned RU5 Village and R1 General Residential General Requirements

Residential subdivision

- All new lots are to have a minimum frontage of 18m and generally are not to exceed a 2:1 boundary ratio.
- If the land is irregular in shape (i.e. cul-de-sac), the minimum width at 6 metres from the street alignment is to be 17metres.
- A battle axe subdivision lot will be considered where there are circumstances that will allow adequate means of access and the amenity of the neighbourhood will not be adversely affected. The minimum width of the access way shall be 6 metres. All services to the lot shall be underground. Generally, only one battle axe lot will be considered for each existing land parcel. Right-of-carriageways will not be considered as legal means of access to any new lot. The area shall not be less than the minimum lot size shown on “Minimum Lot Size Map” (including access handle area).

Residential Infill Roadworks

- In the case of residential infill subdivision (where no new road opening involved) the road frontage construction works requirements of this chapter will apply as determined by Councils Director Technical Services.

Parks and reserves

- Proponents may be required to set aside proportionately 0.5 hectares out of every 10 hectares or part thereof of land to be subdivided, for parks and/or reserves (does not apply to drainage reserves). Council may consider accepting a cash contribution in lieu of dedication as agreed by way of a Voluntary Planning Agreement.

- This provision shall only apply to subdivisions where it is proposed to create 10 or more residential allotments and where the development generates the need for additional public parks in the vicinity to that already existing.

Stormwater drainage

- In subdivisions where the land cannot be drained to the street frontage, the proponent shall provide common inter allotment drainage lines, and appropriate easements as well as meeting the cost of construction of the drainage works.
- Applicants are to demonstrate that post development surface stormwater drainage will not exceed pre-development stormwater flows.

Subdivisions involving the opening of a public road

Roads

- Design specifications for public streets shall generally be as follows shown in Table 3:

Table 3 Residential Roads

No of Allotments	Road Reserve Width (metres)	Minimum Carriage Way Width	Kerb Type	Footpath Construction requirements (metres)
Local road – up to 2000 vehicle trips per day)	18.0m (4.0m minimum verges)	9.0m	Concrete	2.5m concrete pavement (on one side of street)
Urban collector road – up to 3000 vehicle trips per day)	20.0m (4.0 minimum verges)	11.0m	Concrete	2.5m concrete pavement (on one side of street)

- The bulb of the cul-de-sac is to have a minimum seal radius of 8.5 metres and boundary radius of 13 metres.
- The cross fall in the carriageway is not to exceed 1 in 24.
- Kerbing and guttering is required to both sides of the road constructed to Council's standards.
- The road pavement is to consist of gravel kerb to kerb with consolidated thickness of at least 150mm, with 2 coat flush bitumen seal, 10mm aggregate plus 10mm aggregate.

Footpaths

- A concrete pavement footpath shall be constructed along one side in each street in accordance with Table 3.
- The pavement shall be 100mm thick concrete reinforced with F72 fabric laid on 50mm compacted thickness of fine crushed or another approved pavement material.
- The width of the pavement is to be 1200mm, with a cross fall of between 1% and 3%.
- Gradients are to be between 0.5% and 16%.
- All footpath and road intersections shall be provided with a pram ramp at a minimum grade of 1:10 in accordance with AS 1428.
- Details of proposed footpaths are to be shown on Engineer's drawings submitted with

the application.

- The other footpath is to be formed and evenly graded from kerb to property boundary and grass seeded and left safe for pedestrian use.

Street Lights

- Street lighting is to be installed at the applicants cost for all new road openings to meet AS1158.6 *Lighting for Roads and Public Spaces*.

Water supply

- Reticulated water supply to be extended to the subdivision at the applicants cost.
- Water mains are to be at least 100mm diameter.
- Where subdivision is to an existing road where no water mains are available to service the land, water mains are to be constructed and extended by the applicant so as to service the land.
- Where a water main is constructed and is capable of servicing other land, the cost to the applicant will be proportional to the number of blocks of land to be serviced from the mains as determined by Council at the time of assessment of the development application.

Sewer mains

- Sewer mains are to be provided to allotments within the subdivision located to a point or points as determined by Council and at the applicants cost.
- The minimum size of sewer mains is to be 150mm diameter.
- Where a sewerage system cannot be connected to an existing Council sewer main by gravity, then a pumping station and rising main will be required to be constructed by the applicant.
- Where a sewer main or pumping station is constructed and is capable of servicing other land, the cost to the applicant will be proportional to the number of blocks of land to be serviced from the main.

Non Sewered Areas

- Where the subdivision is located in a non sewered area the minimum lot size should be 2000m² with a minimum width 40m to allow for a building envelope that enables the erection of a dwelling/garage and location of an adequate on-site effluent disposal field area that allows a minimum buffer of 12m uphill, and 6m downhill of other property boundaries.
- For subsurface irrigation 6m uphill and 3m buffer downhill of property boundaries.

Electricity and Telecommunication Services

- Electricity services are to be provided to each proposed lot at the applicants cost. Council will require underground electricity service in new release areas.
- Where appropriate telecommunication services are to be provided to each proposed lot at the applicant cost.

Easements

- The applicant is to provide any easements required to facilitate the provision of electricity/ sewer/ water services and allotment drainage.

Residential Release Areas Zones R1 and RU5

Objective

- To ensure that our overall development framework is established so that future development may be undertaken in an orderly manner. This will be achieved through the preparation and adoption of a structure plan for each undeveloped residential

area Zoned R1 and RU5.

Structure Plan

- The structure plan must be prepared by the applicant and endorsed by Council prior to an application being made for the development of the land.
- The preparation of the structure plan is to address:
 - A description of the relationship between the land and adjoining land,
 - Provisions for a range of lot sizes and the estimated lot yield,
 - Any sites of conservation, heritage or archaeological significance and how they will be managed,
 - Any sites for community use,
 - The staging and anticipated timing of development,
 - Identification of bicycle and pedestrian path links between the land and other urban development,
 - Identification of drainage lines,
 - Location and areas of any proposed public open space.

Roads

- A collector road layout plan showing linkage with the existing road network.
- Residential neighbourhoods that will allow for a predominantly north south grid pattern of local streets to optimize solar orientation of lots.
- A general grid patterned street network that follows the contours of the land, and
- Any part of the site which adjoins land that is within a watercourse or public open space (including proposed public open space and reserves) must have an interface with a road to provide a highly visible edge and to define the boundary to the natural environs.

Environment

- Appropriate setbacks and/or buffer treatments to any river system and its floodplain, and
- Assessment and identification of any remnant native vegetation to be retained.

Infrastructure

- Arrangements for provision of water, sewer and stormwater drainage infrastructure; and
- The location of service corridors for water and sewer mains and stormwater drainage infrastructure which minimises the removal of native vegetation on the land and adjoining land.

Land Zoned B2 Local Centre and IN1 General Industrial

Commercial subdivision and industrial subdivision

- A minimum frontage width does not apply. However, a development application for subdivision must be able to demonstrate that the size and shape of allotments are appropriate for the proposed use and be able to accommodate off-street parking, loading and unloading and other requirements of the proposal.
- New roads created by the subdivision or the need for existing roads to be upgraded by the subdivision shall be constructed in accordance with Council's development design and construction standards. All costs associated with the development are to be met by the developer.

Width of roadways shown in Table 4 as follows:

Table 4 Industrial Roads

	Road Reserve Width	Sealed Carriageway width	Footpath Construction requirements	Street Lighting to AS1158.6	Kerb Type
Industrial subdivision roads	24m (5.5m minimum verges)	13m	2.5m concrete pavement (on either side of street)	Yes	Concrete

Community Title Subdivision all Zones

- Community title subdivision must include community facilities that are shared between the residents of the development. It is not appropriate that this form of development be used as an alternative to strata title where the only shared component is a driveway.
- A community management statement (CMS) is to be prepared to ensure ongoing compliance with the requirements of Council. The CMS is to accompany the development application for registration with the Land Titles Office.

5. OTHER DEVELOPMENT CONTROLS

The following provisions apply to all zones under WLEP 2013

Access and Parking

Objectives

- Car parking is to be provided on-site which will cater for the increased demand brought about by the development of the site
- Adequate car parking for people with disabilities
- The provision of car parking which is functional, safe and attractive
- Functional loading and unloading facilities are provided to cater for the development of the site
- The construction of car parking areas, service areas and associated areas to be in accordance with good engineering practice

Access and Traffic Generation

Minor development proposals are unlikely to significantly impact the receiving road network; however, consideration of traffic generation and access locations is still required. For more significant developments, Council may require a Traffic Impact Assessment or Parking Needs Study to be prepared addressing the following matters:

- Development involving access off a classified road will be referred to the Transport for NSW (TfNSW) for comment
- *Traffic Generating Development* under Schedule 3 of the State Environmental Planning Policy (Transport and Infrastructure) will be referred to TfNSW as Integrated Development and will require their General Terms of Approval
- The rate of traffic generation associated with the proposed development
- Any impact additional traffic generated may have on traffic efficiency, amenity, safety and road pavement life

Parking Controls

- Car-parking spaces are to be provided on the same lot as the proposed development. Multi-lot land holdings may require consolidation to comply with this control.
- Additional parking spaces required for any new development or redevelopment shall comply with the controls of this section and **Table 6: Off-street Parking Rates**
- Accessible car parking spaces are to be provided in accordance with the Disability (Access to Premises – Buildings) Standards 2010
- Accessible car parking spaces are to be located as close as possible to the main pedestrian entrance and should have regard to the use and function of the building
- Council will apply the controls of this section if it considers a proposed Change of Use requiring consent will produce a substantially different parking requirement than those attributable to the previous use of premises. Parking credit for existing premises will only be given for a lawful or approved use that has commenced and continually operated
- Development proposals that provide less parking than required by this section shall be supported by a parking study
- On-site parking design must meet the relevant Australian Standards (AS 2890.1 and 2890.2 2004)
- Disabled parking to meet Australian Standard (2890.6- 2009) *Off Street Parking for People with Disabilities*
- All required car parking areas, driveways, turning areas and loading areas are paved in either a bitumen seal coat, asphaltic or bituminous concrete, cement concrete, concrete paving blocks or brick paving blocks. The standard of paving required will

be dependent upon the type of development proposed, with regard to traffic loadings including turning areas, loading areas and car parking areas is required. Surface materials to be at the discretion of Council's Director Technical Services

- All parking spaces shall be suitably line-marked and sign-posted and be graded and drained to Council's stormwater system. Lighting at applicants' cost may also be required by Council to meet *AS1158.3.1: 1999.Road Lighting Pedestrian Area*.
- Free and uninterrupted access to car parking areas shall be maintained at all times
- Stacked car parking is only permissible in conjunction with single dwelling houses and dual occupancies. Exceptions to this control are at the discretion of Council
- Car parking areas are to be incorporated into the building or provided at, or behind, the front setback of the building
- Where a use will generate peak parking demands out of business hours and adequate public parking is available nearby Council may give consideration to reducing parking requirements for the development where an applicant can demonstrate peak parking demands do not coincide with business hours. Request for variation must be supported in writing to Council

Table 5 Off-Street Parking Rates

Land Use	Minimum Parking Spaces Required
Bed and breakfast accommodation	1 per guest room
Bulky goods premises	1 per 50m ² Gross Floor Area (GFA)
Business premise	1 per 60m ² GFA
Caravan Parks	1 space per caravan, manufactured home or moveable dwelling site next to site
Cellar door premise	1 per 50m ² GFA
Community facility	1 per 5 seats or per 10m ² of GFA, whichever is the greater
Child care centre	1 per employee plus 1 per 10 children plus set down and pickup points for cars (parking study may be required)
Commercial premises (not listed separately)	1 space per 60m ² GFA
Dwelling houses and Dual occupancy dwelling	<ul style="list-style-type: none"> • 1 space per 1 and 2 bedroom dwelling house • 2 spaces per 3 bedroom dwelling house (may be stacked)
Educational Establishment (Primary and Secondary Schools)	1 space per each full-time employee plus one space for persons with disabilities plus an additional 10% of the total for visitors
Farm stay accommodation	1 per guest room
Food and drink premises, excluding pubs	1 space per 30m ² GFA
Freight transport facilities	1 per employee
Function centre	1 per 5 seats or 1 per 4m ² GFA, whichever is greater
Funeral Home	4 Spaces per 100m ² of GFA plus 1 per 4 seats (Chapel)
Industry	1 space per 100m ² GFA (minimum 2 spaces per single occupation)
Group home / Boarding Houses	<ul style="list-style-type: none"> • 1 per 1 and 2 bedroom dwelling house • 2 per 3 bedroom dwelling house
Health consulting rooms	3 per surgery, consultation or treatment room
Health services facility	3 per surgery, consultation or treatment room
Highway service centre	1 per 5 customer seats or 1 per 10m ² GFA (whichever is the greater) plus 1 per 2 employees
Home-based child care or	1 per employee

Land Use	Minimum Parking Spaces Required
family day care home	
Sex services - Brothels	2 per room offering sex services
Hospital	1 per 4 beds plus 1 per 2 employees
Kiosk	1 per employee
Landscape and garden supplies	1 space per 200m ² of site area and employee parking
Liquid fuel depot	1 per employee plus tanker parking
Motel or hotel accommodation	1 space per unit plus 1 space per 2 employees
Market	2.5 per stall for customers plus 1 per stall operator
Medical centre	3 per surgery, consultation room or treatment room or 1 per 25m ² GFA (whichever is the greater)
Mixed use development	As required for each land use within the development
Moveable dwelling	<ul style="list-style-type: none"> • 1 per 1 and 2 bedroom dwelling • 2 per 3 bedroom dwelling • 1 per dwelling if the dwelling is temporary and is not present on the site for more than 6 in every 12 months
Multi dwelling housing	<ul style="list-style-type: none"> • 1 car space per 1 or 2 bedroom dwelling • 2 car spaces per 3 or more bedroom dwelling • 1 designated visitor space per 3 dwellings
Neighbourhood shop	1 per 20m ² GFA plus 1 per 3 employees
Office premises	1 space per 60m ² GFA
Place of public entertainment	1 space per 10 seats or 1 space per 15m ² of main assembly area, whichever is the greater
Place of public worship	1 space per 10 seats or 1 space per 20m ² of main assembly area, whichever is the greater
Pub	<ul style="list-style-type: none"> • 1 space per 60m² of licensed public floor area • Service delivery vehicles <ul style="list-style-type: none"> ○ 1 per 50 units up to 200, plus 1 per 100 thereafter plus 1 per 1000m² of public area (bar, tavern, lounge or restaurant)
Recreation facilities (indoor)	1 space per 25m ² GFA
Registered club	1 space per 4m ² of licensed public floor area
Restaurant or café	<ul style="list-style-type: none"> • 1 space per 30m² GFA, except for • 1 space per 5m² GFA or • 1 space per 6 seats
Residential Care Facility	1 space per 4 beds
Residential development, other than dwelling houses	<ul style="list-style-type: none"> • 1 space for 1 and 2 bedroom units • 2 spaces per 3 or more bedroom units • 1 visitor car space per 3 units or part thereof
Restricted premises	1 space per 40m ² GFA
Retail premises	1 space per 60m ² GFA
Rural supplies	1 per 60m ² GFA
Service Station	3 spaces per work bay, plus 1 space per 30m ² GFA for a convenience store, plus 1 space per 3 seats for a restaurant
Squash/tennis courts	3 spaces per court
Take-away food and drink premises	Development with on-site seating: 12 spaces per 100m ² of GFA
Vehicle repair station	3 spaces per work bay
Vehicle sales or hire premises	0.75 spaces per 100m ² site area plus 3 spaces per work bay (for vehicle servicing facilities)

Requests for variation to the above standards must be supported by information and data to substantiate that an alternative standard is appropriate. In some cases, this may require a Traffic Impact Statement or Parking Needs Survey carried out by a suitably qualified person. For smaller scale developments including change of uses an applicant can provide their own written justification for variation for Councils consideration.

Land uses not listed in Table 6 are subject to a parking study and/or discretion of Council.

Explanatory Notes

- *Gross Leasable Floor Area means the overall usable area of the building excluding amenities, stairways, lift wells and plant rooms.*
- *Where an existing building comprises an approved or lawful use and does not provide any onsite parking only the extension will be considered for onsite parking needs. Any parking requirements will depend on whether the extensions will result in an intensification of the use.*
- *Ancillary or incidental uses will be assessed as part of the main user of the building i.e. the office of a supermarket will be included in the area of the supermarket and will not be treated as a separate office use.*
- *A use comprising a combination of two or more uses such as combined motor sales and repairs will be assessed as if the two uses existed independently and the required on-site parking provisions will be the aggregation of the independently derived requirements.*
- *The parking provision for restaurants, cafes and function rooms and the like (that may operate outside normal business hours) may be reduced where it is demonstrated that the time of peak demand for parking associated with each facility does not coincide with business hours or where common usage reduces total demand. Each case will be considered on its individual merits.*

Bushfire Prone Land

These provisions apply to all land zoned Bushfire Prone Land

This section applies to all land that is mapped as bushfire prone land within Warrumbungle Shire Local Government Area (LGA) on the Bushfire Prone Map(s) (as amended or replaced)

A bushfire prone area is an area of land that can support a bush fire or is likely to be subject to bush fire attack. Bush fire prone areas are identified on a Bushfire Prone Lands Map. The map identifies bush fire hazards and associated buffer zones within a LGA.

There may also be instances where land is not identified as bushfire prone on the Bushfire Prone Land Map but a bushfire risk is still present so development may need to consider appropriate locations, design and construction to manage bushfire risk.

Objectives

- Meet the statutory requirement for bushfire protection in NSW
- Prevent the loss of life and property due to bushfire by providing for development compatible with bushfire hazard
- Ensure risks associated with bushfire are appropriately and effectively managed while having due regard to development potential, on-site amenity and protection of the environment
- Ensure bushfire risk managed in connection with the preservation of the ecological values of the site and adjoining lands.

Controls

Where a proposed development is on land identified as bushfire prone on the Bushfire Prone Land Map, the design and management of any proposed development on that bushfire prone land must comply with:

- NSW Rural Fire Service Planning for Bush Fire Protection 2019 (as amended or replaced); and
- Australian Standard AS3959 – 2018 Construction of Buildings in Bush Fire Prone Areas (for any Construction Certificate application). A suitably qualified person must provide a schedule of compliance with the applicable construction standards. This schedule will form part of the approval documentation and the applicant will be required to comply with it during the course of construction.

Any development application involving the erection of a dwelling house or alterations and additions to an existing dwelling house in a RU1, RU5 or R5 zone and located on bush fire prone land must be accompanied by a Bushfire Report completed by an appropriately qualified person.

Any development application involving the erection of a dwelling house or alterations and additions to an existing dwelling house in a R1 or B2 zone and located on bush fire prone land must address the requirements contained in the NSW Rural Fire Services (RFS) publication titled "Building in Bush Fire Prone Areas Single Dwelling Applications Kit" found on the [RFS website](#).

Any development that involves the congregation of people in a place that are not related or lie on the premises must be accompanied by a Bush Fire Emergency Management and Evacuation Plan. Information and a guide to developing a Bush Fire Emergency Management and Evacuation Plan can be found on the [RFS website](#).

Agritourism

This section contains general provisions that apply to development for *farm experience premises, farm gate premises and farm stay accommodation*. They also apply to development for roadside stalls unless specified only for farm experience premises, farm gate premises or farm stay accommodation. Specific controls for each of these land uses are provided in the following sections.

Agritourism is generally a tourism-related experience that connects agricultural products, people or places with visitors to a farm. Agritourism has an important role in creating a more direct connection between the primary producer and the end consumer. Through tours, farm stays and other nature-based activities, agritourism allows regional economies to showcase what is special about a region and provides a connection for the visitors to the land.

Objectives

- To allow for tourism development on farms that complements the agricultural use of the land.
- To ensure farm gate premises, farm experience premises and farm stay accommodation are secondary to a commercial farm and do not constrain the agricultural activities on the property or on adjacent lands.
- To ensure farm gate premises, farm experience premises and farm stay accommodation are compatible with the rural character and heritage of the property and do not unnecessarily intrude on the landscape.

Controls

Development for farm experience premises, farm gate premises or farm stay accommodation is to be compatible with the commercial operations of the farm and not restrict the day-to-day functions of the farm.

The design of buildings and structures should enhance the sense of place and reinforce the rural character through the selection of materials and design quality.

The building design and materials should complement and integrate with the existing landscape including scenic values.

The design and placement of buildings, structures and moveable dwellings for farm experience premises, farm gate premises or farm stay accommodation should be clustered on the property where possible, to minimise the amount of land occupied by the development.

Location

Objectives

- To reduce land use conflicts by separating farm experience premises, farm gate premises or farm stay accommodation development from existing land uses on the property or on nearby land.
- To respond to environmental values, risks and constraints including environmentally sensitive lands that involve native vegetation and habitats, waterways, water sources and drinking water catchments.

Controls

The development is not to restrict the day-to-day functions of adjacent farms.

A building, structure, moveable dwelling or activity for farm experience premises, farm gate premises or farm stay accommodation must be located:

- a minimum of 250 metres from residential accommodation on adjacent land or on land that is separated from the landholding by a road
- a minimum of 50 metres from a property boundary or road
- a minimum of 50 metres from a waterway
- a minimum of 500m to 1000m depending on the land use from a boundary for land used for the purpose of forestry, intensive livestock agriculture, intensive plant agriculture, mines, extractive industries, railway lines or rural industries.
- A development may be closer than the above distances to property boundaries and roads if it can be demonstrated that measures incorporated into the design, such as through boundary planting, will appropriately mitigate impacts.
- The design and placement of buildings, structures and moveable dwellings should consider the existing features of the land and climate, including minimising risk from hazards and weather events.
- Buildings and structures should not be placed on the ridgeline or peak of a hill or other visually prominent areas.

Note: Consider the NSW Department of Primary Industries' Buffer Zones to Reduce Land Use Conflict with Agriculture: An Interim Guideline (2018) when setting distances between agriculture and sensitive receivers.

Vegetation and landscaping

Objectives

- To avoid the clearing and removal of native flora and fauna, in particular threatened species and threatened ecological communities
- To ensure buildings, structures and moveable dwellings are sited and designed to complement, enhance and protect existing native vegetation, features and landscapes.
- To minimise the impacts of a development on the environment, including existing vegetation, features, natural resources and biodiversity.
- To ensure landscaping is visually complimentary to the development.

Controls

Existing mature trees and vegetation are to be retained where possible.

A vegetation management plan is to demonstrate how existing native flora (including tree canopies and underground roots systems) and fauna will be protected and maintained during the construction or erection of any new buildings, structures, moveable dwellings or facilities for farm gate premises, farm experience premises or farm stay accommodation and during the ongoing operation of the premises or accommodation.

Landscaping should be used to minimise the physical and visual dominance of development for farm gate premises, farm experience premises or farm stay accommodation, including any car parking and vehicle circulation areas, and should include plants native to the local area.

Water supply and management

Objectives

- To ensure adequate arrangements for water supply for visitors and guests to farm gate premises, farm experience premises and farm stay accommodation.
- To preserve water supply from contaminants generated by visitors and guests to farm gate premises, farm experience premises, farm stay accommodation and roadside stalls.

Controls

A water supply and management plan is to demonstrate adequate potable water supply, both quality and quantity, is available for the proposed use of a site for farm experience premises, farm gate premises or farm stay accommodation. This water supply is to be in addition to water required for fire fighting purposes.

Development is not to adversely impact existing water supplies for residential and primary production uses on the landholding.

Hazards

Objectives

- To ensure development is located to minimise exposure to natural and environmental hazards, including bush fire, flooding and site contamination.
- To protect any part of a development that could be affected by natural and environmental hazards, including bush fire, flooding and site contamination
- To ensure the safety of visitors who could be adversely affected by natural and environmental hazards, including bush fire, flooding and site contamination, for the duration of their stay or visit.
- To provide for safe evacuation assembly points and egress pathways.
- To ensure site contamination is identified and appropriately and effectively remediated before the land is used.

Controls

A development is not to be located in proximity to areas of high bush fire or flooding hazards.

For development for farm experience premises, farm gate premises and farm stay accommodation on bush fire prone land:

- a water tank dedicated for firefighting purposes with a minimum volume as required by Planning for Bush Fire Protection, published by the NSW Rural Fire Service, must be provided on the property a bush fire emergency evacuation plan is to identify when the premises will be on alert and will close, evacuation procedures and assembly points, proposed signage, measures to protect human life and property in the event of bush fire, any vegetation hazard clearing needed, contact details for emergency services and any bush fire maintenance measures required.

For development for farm experience premises, farm gate premises and farm stay accommodation on flood affected land, a flood evacuation plan is to identify when the facility will be on alert and will close, evacuation procedures and assembly points, proposed signage, measures to protect human life and property in the event of flooding, contact details for emergency services and any maintenance measures required.

Evacuation routes from the location of a development to a main road or alternate point of refuge are to avoid flood liable land and bush fire prone land where practicable.

Where a development is proposed on land where contamination is suspected or has been identified, Council's requirements in the Development Control Plan apply.

Note: Development within the flood planning area, defined in the Floodplain Development Manual (April 2005), is to address the matters in clause 5.21 of Council's local environmental plan.

Waste management

Objectives

- To manage waste in an environmentally sensitive manner.
- To ensure management of effluent waste is not detrimental to the local environment

Controls

Development must minimise any impacts on the natural environment and visitor safety caused by waste, effluent disposal and potential contaminants.

A waste management plan for the ongoing use of farm gate premises, farm experience premises or farm stay accommodation is to provide:

- details of the business
- waste types to be managed including through containment, recycling, re-use and landfill
- waste collection and disposal details
- waste minimisation measures
- monitoring protocols to ensure compliance with the waste management plan.

All effluent waste generated by the development and its ongoing use is to be disposed:

- to a reticulated sewerage system connected to the landholding; or
- using a system of sewerage management for which the approval of Council is obtained under the Local Government Act 1993.

All other waste is to be disposed at an approved waste or resource recovery facility.

Organic waste may be disposed of onsite if disposed in a managed composting system where odours and other pollutants are controlled and/or managed.

All recyclables should be separated before disposal.

Onsite waste storage facilities are to have sufficient capacity for the waste generated and be emptied regularly.

Note: Development within the Sydney Drinking Water Catchment is required to have a neutral or beneficial effect on water quality.

Biosecurity

Objectives

- To manage biosecurity risks from pests, disease, weeds and contaminants by effectively minimising impacts, through robust management arrangements, if they cannot be eliminated.
- To ensure the general biosecurity duty is met.

Controls

The planning and assessment of development proposals is to consider the NSW Department of Primary Industries' Managing biosecurity risks in land use planning and development guide (2020) to ensure biosecurity is appropriately addressed, including in relation to:

- buffer zones
- wash down facilities
- designated parking areas
- location to major potable water supply storages and watercourses
- poultry production

- dumping and burying rubbish on site.

A biosecurity plan for ongoing use of farm stay accommodation, farm experience premises or farm gate premises should be prepared in accordance with the NSW Department of Primary Industries' requirements, including the Farm Biosecurity Action Planner at <https://www.farmbiosecurity.com.au/toolkit/planner/>.

Note:

Under the Biosecurity Act 2015, there is a general obligation on people to be aware of their surroundings and take action to prevent the introduction and spread of pests, diseases, weeds and contaminants. In addition, where a biosecurity plan has been developed at places of commercial or educational activities for intensive or extensive agriculture or horticulture, subject to certain conditions, a person including any visitors must comply with the biosecurity plan.

Council will consider relevant biosecurity guidelines to assess a development proposal and determine relevant conditions of consent for the operation of the development.

Traffic, access and parking

Objectives

- To ensure the safety of vehicle movements associated with farm gate premises, farm experience premises or farm stay accommodation, including entry, egress and movement within a property.
- To minimise the impact of traffic on local roads associated with farm gate premises, farm experience premises or farm stay accommodation.
- To ensure adequate parking is available on the property for visitors and employees to farm gate premises, farm experience premises or farm stay accommodation and to deter overflow parking on local roads.
- To ensure safety of pedestrians on a property visiting farm gate premises, farm experience premises or farm stay accommodation.

Controls

For development for farm experience premises, farm gate premises or farm stay accommodation:

- An access point to the property is to demonstrate compliance with the sight distance requirements of AS 2890.1 Off-street car parking and should be adequate to service the development.
- All vehicles (including trucks) should be able to enter and exit the property in a forward direction.
- All parking and loading or unloading of vehicles must occur within the property boundary.

The minimum number of car parking spaces to be provided is:

- 1 space per farm stay accommodation room or cabin, and
- 1 space per moveable dwelling or tent site, and
- 1 space per 2 employees, and
- 1 space per 25m² gross floor area of a building or structure for farm gate premises or farm experience premises, and
- 1 space per 3 visitors for any outdoor farm gate premises or farm experience premises activity, and
- 1 space for persons with disability or limited mobility.

A parking and access plan can demonstrate alternative parking ratios to the above minimum numbers that includes safe separation between visitors and heavy vehicles and farming operations.

Only one driveway is permitted on a property unless the property has a frontage of greater 100m and can accommodate an additional access and egress to improve:

traffic management on the property or on and off the road
separation between the farming operations and the development, or
resident, employee and visitor safety.

Car parking areas should not form a visually prominent element of the rural landscape or be highly visible from the road frontage and should be located behind the front building line.

Car parking areas should be finished in a surface that will allow for vehicle movements in all weather conditions.

Signage

Objectives

- To ensure signage for farm gate premises, farm experience premises, farm stay accommodation or roadside stalls does not detrimentally affect the landscape or road corridor.
- To require appropriate signage within the property boundary to assist visitors and guests relating to:
 - the location of activities, facilities and interest points associated with farm gate premises, farm experience premises, farm stay accommodation or roadside stalls,
 - essential safety information including evacuation procedures in a natural disaster or other emergency.

Controls

Signage for farm gate premises, farm experience premises, farm stay accommodation or roadside stalls should be in keeping with the rural character and the nature of the operations on the landholding.

All signage for farm gate premises, farm experience premises or farm stay accommodation should only be located within the boundary of the landholding.

Business identification signs for farm gate premises, farm experience premises, farm stay accommodation or roadside stalls are limited to a maximum of two (2) signs facing a road frontage on the landholding.

Business identification signage should only promote the business activity and the goods and services offered on the landholding. Any sign must:

- have a maximum height of 3 metres, and
- have a maximum area of 3 square metres, and
- if it is illuminated, have lighting that complies with *AS/NZS 4282:2019 Control of the obtrusive effects of outdoor lighting*.

Evacuation signage must be located near the farm gate premises, farm experience premises and farm stay accommodation, the property entrance and emergency assembly points.

Waypoint markers should be provided to assist visitors and guests traverse a property where farm gate premises, farm experience premises or farm stay accommodation operate.

Ongoing operations

Objectives

- To provide for the ongoing management of farm gate premises, farm experience premises and farm stay accommodation.
- To ensure farm gate premises, farm experience premises and farm stay accommodation minimise impacts on the natural environment and visitor safety.
- To ensure visitors and guests have access to important safety and operational information while on a property where farm gate premises, farm experience premises or farm stay accommodation operate.

Controls

A management plan for the ongoing operation of farm experience premises, farm gate premises and farm stay accommodation is to provide:

- a description of the development to be carried out on the property
- a map of where the development will be on the property, relevant dimensions and key features on the land
- the proposed months, days and hours of operation of the farm gate premises, farm experience premises or farm stay accommodation
- the maximum number of guests at one time for the farm gate premises, farm experience premises or farm stay accommodation, and how this will be monitored
- how visitors and guests will be advised to:
 - limit impacts to the operational farm,
 - preserve and protect existing native flora, fauna and waterways, heritage items and Aboriginal heritage located on the property,
 - minimise any biosecurity risk through dispersal of weeds, seeds, insects and contaminants,
 - manage their waste, and
 - be alerted as to risks that may be present on the property such as natural hazards or changing weather
 - measures to mitigate adverse environmental and amenity impacts
 - the way vehicles will access the landholdings and the premises
 - any safety hazards on the property and how they will be managed to ensure the safety of visitors and guests.

Farm stay accommodation

Objectives

- To diversify the uses of agricultural land for tourist-style accommodation without adversely impacting the principal use of the land for primary production.
- To ensure farm stay accommodation does not detract from existing environmental values, scenic landscape values, infrastructure and adjoining land uses.
- To protect the amenity and privacy of adjoining properties, including visual and acoustic privacy, from farm stay accommodation.
- To provide accessible farm stay accommodation suitable for people with disability or limited mobility.

General matters for consideration:

- Development should not result in noise or pollution that will have a significant adverse impact on the following on or near the land:
 - residential accommodation
 - primary production operations other land uses.
- Development should not have a significant adverse impact on the following on or near the land:

- the visual amenity or heritage or scenic values
- native flora or fauna, particularly threatened species and ecological communities
- water quality
- traffic
- the safety of persons

Controls

Farm stay accommodation that comprises moveable dwellings (tents, caravans, camper trailers, tiny houses) must be on a landholding that is a minimum of 15 hectares.

A building or manufactured home for farm stay accommodation (except the use of an existing building or manufactured home) must be on a landholding that is a minimum of 15 hectares.

Farm stay accommodation, including in moveable dwellings, is limited to:

- a maximum of 20 guests at any one time on a landholding, and
- a maximum stay for guests of 21 consecutive days.

The maximum number of buildings and manufactured homes used for farm stay accommodation on a landholding is six (6).

The maximum number of moveable dwellings used for the purposes of farm stay accommodation on a landholding is six (6).

To address fire safety:

- buildings are to be separated from other buildings, and
- moveable dwellings are to be separated from buildings and other moveable dwellings (except tents and similar portable and lightweight temporary shelters).

The gross floor area of a new building or manufactured home for farm stay accommodation must not be more than 60 square metres.

The gross floor area of part of an existing building or manufactured home used for farm stay accommodation must not be more than 60 square metres.

The height of a moveable dwelling used for farm stay accommodation is not to exceed 4.5 metres.

The height of a building or manufactured home for farm stay accommodation is not to exceed 4.5 metres.

Where mains water is not available, a minimum of 600kL of water is to be provided in addition to that required for the dwelling house on the property and for firefighting purposes if on bush fire prone land.

A supply of potable water must be made available in each farm stay accommodation.

One toilet per 10 staying guests in farm stay accommodation on the landholding is to be available in an accessible location. At least one toilet must be a unisex accessible toilet.

A building or manufactured home used for farm stay accommodation (except for the use of an existing dwelling for farm stay accommodation) must be:

- on the same lot as an existing lawful dwelling house, or
- on a lot that is not less than the minimum lot size for a dwelling house permitted

under Council's LEP.

Farm gate premises and farm experience premises

Objectives

- To allow for tourism and related commercial uses at a scale that does not adversely affect the principal use of land for primary production.
- To ensure farm gate premises and farm experience premises do not detract from existing environmental values, scenic values, infrastructure and adjoining land uses.
- To protect the amenity and privacy of adjoining properties, including visual and acoustic privacy, from farm gate premises and farm experience premises.
- To provide for the sale of locally grown and manufactured produce in appropriate rural locations.
- To adequately provide services and facilities for visitors and guests on the property, including accessible facilities.
- To manage the number of visitors to a landholding to address cumulative effects of traffic on roads.

General matters for consideration

Development should not result in noise or pollution that will have a significant adverse impact on the following on or near the land:

- residential accommodation
- primary production operations
- other land uses.

Development should not have a significant adverse impact on the following on or near the land:

- the visual amenity, heritage or scenic values
- native flora or fauna, particularly threatened species and ecological communities
- water quality
- traffic
- the safety of persons

Controls

The gross floor area of a building (or part of a building) for farm gate premises or farm experience premises is not to be more than 200 square metres.

The total footprint of all buildings used for farm gate premises and farm experience premises on the landholding is not to exceed 500 square metres.

The height of a new building for farm gate premises or farm experience premises is not to exceed 7 metres for landholdings ≤ 10 ha and 10m for landholding > 10 ha.

Buildings should be separated to address fire safety.

The hours of operation of farm gate premises are:

- 8am to 5pm Sunday to Friday and public holidays, and
- 7am to 5pm on Saturdays

The hours of operation of farm experience premises are:

- 8am to 6pm Sunday to Thursday and public holidays, and
- 8am to 12am (midnight) Friday and Saturday.

The maximum number of visitors for farm gate premises is not to exceed 100 on a landholding at any one time.

The maximum number of visitors for farm experience premises is not to exceed 50 on a landholding at any one time.

The maximum number of visitors for all farm gate premises and farm experience premises is 100 on a landholding at any one time.

Farm experience premises are limited to 52 events per year, including a maximum of 4 events per year after 6pm that have amplified noise.

Adequate toilet facilities are to be provided. At least one toilet must be a unisex accessible toilet.

Amplified noise for farm gate premises and farm experience premises must be a maximum of [insert dB] dB at the property boundary of the closest residential dwelling.

Roadside stalls

Objectives

- To ensure roadside stalls are in keeping with the rural environment and do not distract road users from safe driving practices.
- To ensure access to and from roadside stalls occurs in a safe manner.

Controls

The design of a roadside stall should complement the natural landscape.

The maximum height of a roadside stall is 4 metres.

A roadside stall must be located within the boundaries of the landholding.

A vehicle access point to a public road is to comply with AS/NZS 2890.1: 2004 Parking facilities - Off-street car parking.

Car parking spaces may be located on a road verge or fully within the boundaries of the property and should be provided for at least three vehicles.

Note: The maximum gross floor area of a roadside stall is specified in clause 5.4(8) of the LEP.

Any work required in the road reserve will require approval of the relevant roads authority under the Roads Act 1993.

Temporary occupation of a building during erection of a dwelling

These provisions apply to RU1, R1 and R5 zones.

Approval to occupy a temporary dwelling is subject to the following conditions:

- 1) Development consent is required to be obtained from Council for temporary occupation/use of a building as a temporary dwelling. This may be lodged with the DA for the dwelling house
- 2) A development consent (approval) to occupy a building as a “temporary dwelling” is unable to be issued until such time as Council development consent for the construction of a permanent dwelling has been issued
- 3) Approval must be obtained under Section 68 of the Local Government Act 1993 for an On-Site Sewerage Management System (OSSMS) to service any temporary facility. (it is a condition of such approvals that they not be used until Council gives notification in writing that the system is installed substantially in accordance with the approval)
Note: The approved OSSMS may ultimately be used to service the permanent dwelling if the conditions of approval allow so
- 4) Development consent for the occupation/use of a building as a temporary dwelling shall only be granted for a period of 12 months. Council may extend the term for up to an additional 6 months to coincide with the expected completion date of the building work under extenuating circumstances. Such circumstances shall be required to be justified
- 5) Council will only consider the erection and/or occupation of a building for occupation/use as a temporary dwelling an RU1 and R5 Zones. Council will only consider temporary occupation on a R1 zone where the site comprises of a large residential holding of at least 5000m² and can provide setbacks of 50m to the nearest dwelling house so as not to impact on the amenity of the neighbour.
- 6) To provide safe and hygienic accommodation a temporary building shall have access to the following:
 - a. Potable (drinking) water
 - b. An approved and commissioned OSSMS
 - c. A bath or shower
 - d. Food preparation and cooking facilities
 - e. Adequate natural light and ventilation
 - f. Safe access and egress from the building
 - g. Regular refuse collection
 - h. An approved hard-wired smoke detector system with battery backup.
- 7) Prior to the occupation/use of a building as a temporary dwelling the applicant shall obtain a notice in writing that the OSSMS is installed in accordance with the approval issued under Section 68 of the Local Government Act 1993.
- 8) The temporary building is required to comply with NSW Rural Fire Service Planning for Bushfire Protection (current version). A bushfire risk assessment is required to accompany a development application relating to bushfire prone land.
- 9) At the end of the approval period the applicant/occupier shall be required to render the building non-habitable. Written evidence together with photographs showing the inside of the building shall be provided to Council to ensure that Council’s records relating to the property are up to date.

Installation of manufactured home, moveable dwelling or associated structure

The following provisions apply to residential and rural zones under WLEP 2013.

Purpose

The purpose of this policy is to:

- Acknowledge that the installation of transportable homes is different to traditional dwelling construction in the legislative and approval process
- Distinguish that there are different types of transportable homes which required different considerations and approval processes
- Ensure that Council exercises its functions as the approval body consistently and in accordance with the Environmental Planning and Assessment Act 1979 and the Local Government Act 1993
- Provide information to all relevant stakeholders on the approval process for transportable homes within the Shire

Definitions

Manufactured Home – is defined in the Local Government Act 1993 as ‘a self-contained dwelling (that is, a dwelling that includes at least one kitchen, bathroom, bedroom, and living area and that also includes toilet and laundry facilities) being a dwelling:

- a) That comprises one or more major sections and
- b) That is not a motor vehicle, trailer or other registrable vehicle within the meaning of the Road Transport Act 2013, and includes any associated structures that form part of the dwelling

Moveable Dwelling – is defined in the Local Government Act 1993 as:

- a) Any tent, caravan or other can or portable device (whether on wheel or not), used for human habitation, or
- b) A manufactured home, or
- c) Any conveyance, structure or thing of a class or description prescribed by the regulations for the purposes of this definition

Associated Structure – is defined in the Local Government Act 1993 as:

- a) A carport, garage, shed, pergola, verandah or other structure designed to enhance the amenity of a moveable dwelling and attached to or integrated with, or located on the same site as, the dwelling concerned, or
- b) A separate wall between two moveable dwellings

Need to lodge a Development Application (DA)

All proposals to install a manufactured home on land require the lodgement of a DA and an application for Section 68 approval Local Approval. The applicant needs to submit an application for development together with plans and specifications indicating the following:

- Design certified by a practicing structural engineer indicating the building is structurally sound
- Be installed in accordance with the specifications in the engineer’s certificate or such other specifications as are in the approval for the installation on the land
- Have compliance plates attached

These requirements are intended to ensure that the home meets relevant health, safety and amenity standards.

In determining a DA to install a manufactured home, Council is required to consider such of

the matters referred to in Section 4.15 of the EP&A Act as are relevant to the subject development.

Need for a Construction Certificate

A Construction Certificate is **not** required for installation of this type of home. This is because a Construction Certificate is only required for building work or subdivision work, and installation of a manufactured home is not erection or a building for the purposes of EP&A Act 1979. The Section 68 Application and approval under the LG Act 1993 effectively replaces a Construction Certificate.

Instead of requiring a Construction Certificate, certification by structural engineer/s and compliance plates are relied upon.

Manufactured homes require a final completion certificate to be issued by Council prior to occupation to ensure the health and amenity of the occupants.

BASIX

A BASIX Certificate is not required for manufactured homes as they are not within the definition of a BASIX affected building under the EP&A Regulation 2000. Currently, BASIX only applies to buildings as defined in the EP&A Act.

Other requirements

Some or all of the following will also be necessary, depending on the nature and location of your development:

- A separate S68 application to install an On-site Sewage Management System (OSSMS) is required in a non sewerred area. This is to enable all the plumbing and drainage associated with the building to be installed, inspected and approved. The Application form is available from Council.
- Access to the site – any existing or new access from a public road to the property boundary, must comply with Council's driveway access crossing requirements or RMS requirements where fronting a classified road.
- Evidence of compliance with the Home Building Act 1989. If you are using a licensed builder for the work that exceeds \$20,000 in value you must obtain Home Building Compensation Fund OR if you opt for an Owner-Builder Permit and the work exceeds \$10,000 in value, you must apply for an owner builder permit at NSW Office of Fair Trading, this requirement also applies to all associated structures.

Other Specialist Reports

For certain a development, Council requires other specialist reports for issues such as geotechnical, flood and site contamination.

Development on Bush Fire Prone Land

All developments on bushfire prone land are assessed in accordance with the NSW Government document titled "Planning for Bushfire Protection" available from www.rfs.nsw.gov.au

Development Applications for installation of buildings onto bushfire prone land should be accompanied by a bushfire consultant's report or a completed Bushfire Assessment Report depending on the zoning of the land.

This assessment will determine appropriate standards for distances to vegetation (called asset protection zones), construction standards, on site water storage and pump plus a variety of other matters.

If you are unsure if your site is within a bushfire prone area, contact Council's Development Services.

Application package is to include (but not limited to)

- Online Application form for the proposed development
- Owners Consent
- Owner Builder Permit OR Home Builders Compensation Fund Certificate – *if the connection of services and the undertaking of residential building work including specialist work and site preparation work, are involved in the siting of a transportable or manufactured dwelling that is to be used as a residence, then Home Building Compensation Fund would be required. Evidence of the existence of a valid Home Building Compensation Fund would be required in the development notice given to Council if the proposed work meets the conditions outlines in Clause 98B of the Environmental Planning and Assessment Regulation 2000. Please note that the Home Building Compensation Fund threshold of \$20,000 includes labour, material supplied by the contractor & GST (in general terms, the total contract price)*
- Plans of the development
- Relevant Structural Engineers Certifications and specifications
- A Local Approval (sometimes called a Section 68 Application) for any on-site sewage management system
- Relevant application fees

Contaminated Land

These provisions apply to all zones under WLEP 2013

Introduction

Pursuant to the provisions of the Environmental Planning and Assessment (EP&A) Act 1979, Local Government Act 1993, Contaminated Land Management Act 1997 and the Contaminated Land Management Regulation 1998, Council has a duty of care when considering Development Applications, to consider fully the possibility of land contamination and the implications it has for any proposed future use of land.

In recognition of its duty of care, Warrumbungle Shire Council will adopt a precautionary approach to its consideration of applications involving contaminated or potentially contaminated land. The object of this approach is to enable any land contamination issues to be identified and dealt with at an early stage in the planning process.

The processes of identifying, evaluating and remediating contaminated land are documented in the *Managing Land Contamination: Planning Guidelines SEPP 55* developed by the Department of Urban Affairs & Planning and the Environment Protection Authority in 1998; and *National Environment Protection (Assessment of Site Contamination) Measures 1999*. Council considers these guidelines to be a mandatory reference for consultants assessing contamination levels and undertaking remediation exercises.

Council views contamination as a subset of general pollution and will seek, in its assessment and determination of all applications, to ensure the continued compatibility of all development by minimising the potential for polluting discharges, fugitive emissions and controlled spillages by appropriate site management techniques. It is incumbent upon all developers to design and manage their sites in a manner consistent with this objective.

It does not follow that adherence to Council's policy and procedure alone is sufficient to ensure approval of an application for the rezoning or development of contaminated land. Council will consider each and every application on its merits having particular regard for the circumstances of each individual case.

Objectives

- Ensure that the potential for the contamination of land is considered in the planning and development process
- Ensure that strategic planning and development decisions appreciate matters relating to the potential for previous land uses to contaminate land
- Ensure that the Council exercises its functions relating to land development with all reasonable care and due diligence
- Ensure that the development of contaminated land does not result in unacceptable levels of risk to public health or the environment
- Ensure that site investigations are undertaken in a satisfactory manner in accordance with appropriate legislation, regulations, guidelines and standards
- Ensure that the community is not negatively impacted through increased health and environmental risks from land contamination issues

Controls

- Identification of previous land uses which may have caused potential contamination risks to land
- Identification of potential pollutants which may have contaminated land

- Assessment of site-specific contamination relevant to the redevelopment or rezoning of land and appropriate proposed land uses
- Investigation and assessment of contamination in accordance with appropriate legislation, regulations, guidelines, and standards
- Remediation of contaminated land to a standard appropriate for the proposed land use
- Identification of potential off-site impacts associated with land contamination
- Notification of significant risk of harm to the NSW Environment Protection Authority (EPA) if required

What is Contamination?

Contamination can result from a number of past and/or present land use activities which may include, but are not restricted to:

- The controlled or uncontrolled disposal of wastes, including sewerage or trade wastes
- Accidental leakage
- Leakage during plant operations, storage or transportation of raw materials, finished products or wastes
- The inappropriate storage of handling of substances

The list at the rear of this section (Table 7 Page 69) provides a quick reference guide to some potentially contaminating activities. This list should be consulted as part of the initial enquiry process undertaken prior to the lodgement of an application with Council.

Council has developed a set of procedures to be followed for rezoning proposals and for Development Applications to assess the potential of site contamination. These procedures allow for a merit based consideration of land contamination issues, that is in considering the implications of contamination, Council will have regard for the sensitivity of a proposed land use in addition to any technical standards or requirement published by the NSW Environment Protection Authority (EPA), the Australian and New Zealand Environment Conservation Council (ANZECC), the National Environment Protection Council (NEPC), the National Health and Medical Research Council (NH&MRC) or any other relevant authority.

Duty to report

The Contaminated Land Management Act 1997 requires individuals to notify the NSW Environment Protection Authority (EPA) if they become aware that their activities have contaminated land so as to present a significant risk of harm to public health or the environment.

The Act also required landowners to notify the EPA if they become aware that their land has been contaminated so as to present a significant risk of harm to public health or the environment. This requirement applies to all property owners whether the contamination occurred prior to or after the landholders ownership of the property.

Any notification of significant risk of harm to the EPA must be done as soon as practicable after becoming aware of the potential for significant risk of harm. This notification must be undertaken in accordance with the Contaminated Land Management Act 1997.

To assess the risk to public health or the environment associated with contamination, the land owner and/or persons who have caused the contamination should consult with the Guidelines on *Significant Risk of Harm from Contaminated Land and the Duty to Report* developed by the NSW Environment Protection Authority.

Procedural principals

There are 4 main stages in the assessment of contamination associated with the development contaminated land, as detailed by the *State Environmental Planning Policy (Resilience and Hazards)*.

At each stage it is the applicant's responsibility to provide the necessary documentation to Council and to meet their costs of the work required to prepare such documents. If Council is unsatisfied with the procedure or findings of a report it may choose to obtain an independent review of the investigation and reports completed, which would also be at the cost of the applicant or property owner.

The stages are as follows:

- **Stage 1 Preliminary Investigation** – This stage involves an investigation and reporting of the site history and is typically based on readily available information such as historical record of land use, aerial photographs and consultations with previous occupants and relevant authorities.

At this stage some initial sampling and analysis may need to be undertaken by a suitable qualified environmental consultant and in accordance with the ANZECC/NH&MRC guidelines.

- **Stage 2 Detailed Investigation** – Should the initial investigations indicate that further assessment is required or if in the opinion of Council, it fails to clearly demonstrate that the land is suitable for its proposed use, a detailed assessment and evaluation is to be submitted.

The detailed investigation stage is required to provide information regarding the extent and degree of contamination. This detailed evaluation stage involves formal sampling by a suitable qualified environmental consultant in accordance with the ANZECC/NH&MRC guidelines. Typically, a site specific work plan is developed during this stage, based on previous investigations.

- **Stage 3 Remediation** – The remediation of the site must be managed through the completion of a Plan of Remediation or Remediation Action Plan (RAP). This RAP must detail the proposed method of remediation, the reason for remediation and final goals of remediation.

The basis of site remediation is to select a socially acceptable and cost effective management strategy which mitigates threats to, and provides protection for public health and the environment as well as allowing flexibility in the future use of the land. This process is facilitated by selecting appropriate criteria which is recognised as being a suitable level of contamination for the proposed land use.

Once a clean-up technique or management strategy has been chosen and used, validation of the clean-up must take place to ensure that the measures taken are adequate for the protection of local amenity, public health and the environment.

- **Stage 4 Validation and Monitoring** – The purpose of validation is to confirm that the remediation process has achieved the objectives and goals of the Remediation Action Plan (RAP) and has remediated the land to a level suitable to the proposed land use.

The validation of a site must be undertaken and reported on by a suitable qualified

consultant who has managed the site investigation and remediation process. The consultant should follow the relevant EPA guidelines when validating a site. Ongoing monitoring of contaminated sites may also be required to ensure that any identified pollutants are not permitted to migrate from the site. Any proposal for ongoing monitoring must be detailed in the RAP completed for the remediation of the site or the final validation report, and must also include a legal agreement from the property owner that this monitoring will be undertaken.

Council required that submission of preliminary investigation report (including site history information and documentation of known or potential sources of contamination) at the following stages:

- **Rezoning Applications** – with initial Rezoning Application to Council; and
- **Development Applications** – where a change of land use is proposed or where the subject or immediately adjacent land is suspected of contamination (consideration will be given to contamination at the DA stage)

Subsequent stages of the SEPP 55 Guidelines and/or Council's policy will not apply in cases where:

- A preliminary investigation report clearly and unequivocally demonstrates, in the opinion of Council, that the contamination of the subject land and its surrounds has not occurred and/or;
- The subject land has previously been remediated to an appropriate standard acceptable to Council for the proposed land use.

At any time throughout the assessment process of an application for potentially contaminated land, Council may request a separate independent audit review of work or conclusions drawn by an applicant's consultant. Should an independent review be required the cost of that review is to be met entirely by the applicant. Although paid for by the applicant, the independent consultant is engaged by Council and must report direct to Council.

Council required that an independent consultant be suitably insured and be accredited under the New South Wales legislation.

Where a detailed site evaluation indicates that the level of contamination on a particular site is high, Council may require the applicant, developer and/or landowner (or future landowners) to provide indemnification to Council that he/she or they, will at all times comply with any conditions of development approval relating to the remediation, control, monitoring, inspection, reporting and maintenance of the land contamination. This may be in its applicable state at the time of development approval or in a residual state following remediation works, as the case may be. Such indemnification will be prepared at the applicant's cost.

Procedures for Development Applications

Development Applications which propose a change of land use or are the subject of or immediately adjacent to land which is potentially contaminated, will be assessed as per the procedures detailed by this Section of the DCP.

The key requirements of this procedure are:

- The submission, by the applicant, of a preliminary investigation report at the time of lodgement of the application with Council.
- Should Council's assessment of the initial identification report indicate the need for further information or investigation, Council may call for additional sampling and/or justification to be submitted, at the applicant's cost.
- Where it has not been clearly demonstrated that land is suitable for its proposed use

in its present state, Council will require the submission of a detailed site investigation report.

- Where land is found to be free of contamination of where, in Council's opinion, the extent of contamination does not pose a threat to human health or the environment, Council may proceed to determine the application without reference to clean-up standards or remediation requirements.
- If the land is found to be contaminated, details of an appropriate Remediation Action Plan (RAP) are to be submitted for the consideration of Council or where remediation is not practical the application shall be refused.
- If Council is uncertain about the findings of a preliminary investigation report or a detailed site investigation, it may require an independent assessment of work undertaken, as documented in this Section of the DCP.
- Depending on the degree of contamination, and the remediation strategy proposed, Council may decide to issue a deferred commencement consent or require indemnification from the development or landowner that they will develop, maintain and monitor the land as required by the terms of any consent.
- Council will require any necessary remediation to be validated by an independent environmental consultant.

Information pertaining to land contamination which has been submitted as part of any relevant rezoning application may be sufficient to satisfy some of the requirements of this policy for DA's.

It is incumbent upon an application to demonstrate to Council that previous investigations, and/or remediation strategy/works, carried out at any stage in the land development process, satisfy the provisions of this policy.

Table 6 Contamination Table

Landuse	Potential Contaminants
Agriculture / horticulture	Land heavily treated with persistent chemicals such as arsenic and organochlorine based chemicals (e.g. banana plantations, cotton and sugar cane fields, local orchids and horticulture plantations and market gardens) and organophosphate-based chemicals
Airports	Hydrocarbons (fuels and organic solvents), oils and heavy metals
Asbestos production and disposal	Asbestos based waste such as asbestos tailings (usually contains 2% asbestos from asbestos mines)
Battery manufacture and recycling	Lead, manganese, zinc, cadmium, nickel, cobalt, mercury, silver, antimony, sulfuric acid
Chemical and Petrochemical Works	A variety of contaminants from the production, recovery and storage of organic and inorganic chemicals including; petrochemicals (e.g. tar and bitumen), solvents such as chloroform, trichloroethylene and tetrachloroethylene from dry cleaning establishments, fertilisers, pesticides, pharmaceuticals, soaps and detergents, dyestuffs, inks and paints, acids and bases, asbestos)
Concrete and Brick Industry	In areas with clay deposits, open cuts were created from the extractive activities. These open cuts which could reach a depth of up to 10 metres, were progressively filled with waste and in particular industrial waste

Docks and railway land, especially large sidings and depots	Oils and hydrocarbons (including polyaromatics such as PAHs, diesel fraction), volatile chlorinated hydrocarbons (such as VOCs), heavy metals (copper, lead, mercury, chromium and zinc), and paints, arsenic, herbicides and asbestos
Drum reconditioning Gasworks, other local carbonization plants and ancillary by products works	Chemicals such as solvents, paints, dyes and oils Hydrocarbons such as naphtha, especially aromatic hydrocarbons such as PAHs, coal tar derivatives, phenolics, "spent oxide" (iron or calcium oxides containing high concentrations of free sulphur, sulphides, sulphates), cyanides (free and complex), and asbestos
Heavy engineering installations, e.g. Shipbuilding, car manufacturing, electrical and electronic manufacturing Installations involving the processing, use or disposal of radioactive materials	Heavy metals, oxides, antifouling paints (copper and tributyl tin based), lead, asbestos
Landfills and other water disposal and storage sites including transfer stations	Cobalt (e.g. Gamma sterilisation and medical therapy), strontium, cesium and radium (e.g. Research and medical applications), uranium (e.g. Research), thorium (e.g. Industrial processing of mineral sands), plutonium and tritium isotopes and others
Metal/metallurgical Industry	Putrescible waste (e.g. Food waste), paper, glass, plastics, metals and other materials generated mainly by householders and dumped into municipal landfills; bacteriological contaminants (e.g. Infectious waste) and cytotoxic chemicals from clinical waste, pesticides from contaminated drums, ash containing heavy metals from coal fired power stations or other incinerators, aluminium and iron from water treatment residuals, heavy metal based waste from mining activities and liquid waste such as solvents, generated mainly by industry – in controlled and/or secured landfills. Refining or recovery of metals, electroplating and metal finishing – Phosphates, nitrates, nitrites, sulphates, heavy metals (cadmium, chromium, copper, lead, nickel, zinc, cobalt etc.) and cyanides (from alkali cleaning), aromatic compounds such as benzene, toluene, xylenes, styrene and chlorinated hydrocarbons (from solvent cleaning and paint removal), polycyclic aromatic hydrocarbons (PAHs) (from colouring and bituminising agents), PCBs and mineral oils, asbestos and beryllium
Metal Mines	Acids, cyanides and heavy metals such as cadmium, copper and zinc from mine tiling and processing plants, asbestos and sulphates
Mining and Extractive Industries Munition Production and Testing Sites	Handling and storage of ores and carbonaceous materials. Also hydrocarbon material from fuel storage and handling Mercury and lead based compounds, RDX, sulphur, nitrates (organic and inorganic), TNT, detonating devices and others
Oil Refineries, Petroleum Storage and Distribution	Petroleum hydrocarbons and lead from oil refineries, petrol stations, above and underground storage tanks and distribution sites
Paper and Printing Works	Ash, hydroxides, peroxides, acids, foaming agents, chelating agents, (e.g. DTPA), dyes

Pesticide storage areas	Areas where vehicles used for the transport and storage of pesticides are washed and area where tanks are used to store pesticides – insecticides, fungicides, and herbicides
Power Stations	Polychlorinated biphenyls (PCBs), ash (heavy metals), asbestos
Scrap yards	Heavy metals, residues from drums including chlorinated hydrocarbon solvents
Smelters, Foundries, Iron and Steel Works	Lead, copper, zinc, cadmium, mercury, aluminium, fluorides and acid from smelters and foundry operations, PAHs (Poly Aromatic Hydrocarbons), cyanides, heavy metals and benzene, toluene and xylene (BTX), ethyl benzene, asbestos, naphthalene, tars and ammonium sulphate, from steel works
Stock dipping	Activities on cattle tick and sheep dip sites – Chemical (mainly tickicides) disposed of in the 1960s and 1970s such as DDT, arsenic, BHC, delnev, carbaryl and ethion; current chemicals in use (e.g. Tactic, arnitraz, cypermethrin, bendiocarb, deltamethrin, flumethrin, bayticol, diazinon, chlorfenvinfos and barricade “s”)
Tanneries	Material derived from the hides and skins such as grease and dung; chemicals used in the preservation and tanning process such as sulphate, lime, sulphide, hydroxides, chlorides and arsenic based compounds for pre-treatment, tannins, sulphites and chromium salts for tanning
Termite/ant control	Where substantial areas of soil may be contaminated with organochlorine residues (e.g. Dieldrin, heptachlor, chlordane)
Timber Treatment Works	Creosote, polycyclic, hydrocarbons, polycyclic aromatic hydrocarbons (PAHs), copper, chromium, arsenic, boron and pentachlorophenol (PCP) from industries using or making wood preservatives and other organochlorines

NB: It is not sufficient to rely solely on this list to determine whether a site is likely to be contaminated or not. The list is a guide only.

Outdoor Advertising Signage

These provisions apply to all zones under WLEP 2013

Objectives

- New buildings are to integrate designated signage areas within the building form
- Size, colour and design compatible with the building to which they relate and its streetscape
- Signage should be clear, simple and concise. In some instances, graphics symbols may be more effective than words
- Where more than one shop or business within a building, signs should be coordinated in height, shape, size and colour
- Signs should not dominate their surroundings
- Advertisements should be designed and located so that they do not obscure driver's views of other cars, trains, pedestrians, traffic signals and traffic signs
- Advertisements should not resemble road signs in colour, shape, layout to working in any way that may confuse motorists

Signs

- Awning signs must:
 - Be erected horizontal to the ground and at no point less than 2.6m from the ground
 - Not project beyond the awning
 - Be securely fixed by metal supports
- Fascia signs must not:
 - Project above or below the fascia or return end of the awning to which it is attached
 - Not to extend more than 300mm from the fascia or return end of the awning
- External light source must be at least 2.6m above the ground if the sign projects over a public road
- Flush wall sign:
 - The area of the sign shall not exceed 20% of the area of the wall on which it is fixed or painted
 - Not project above or beyond the wall to which it is attached
 - Face of the sign must be parallel to the wall on which it is attached
- Pole or pylon sign must be a minimum of 2.6m above the ground
- Projecting wall sign must be:
 - Minimum height of 2.6m above the ground
 - Erect at right angles to the wall of the building to which it is attached
- Top hamper sign must not
 - Extend more than 200mm beyond any building alignment
 - Extend below the head of the doorway or window to which it is attached
- Sandwich board signs (Council footpath in B2 Zones)
 - Located on footpath so as not to obstruct pedestrians
 - \$20 million Public Liability insurance required
 - Obtain permit from Council

Diagram 4 Street Signage



Prohibited Signs

The following types of signs do not contribute to the character of the towns or rural areas and are prohibited.

Table 7 Prohibited Signs

Type of Sign	Description of Signage
Advertising fixed to trees Billboards	Any sign that uses a tree as a pole for mounting Additional billboards where the structure is erected for the express purpose of displaying advertising not associated with the use of the land are prohibited
Bunting	Small flags attached to a single siring mounting between posts or poles.
Illuminated wall signs	Signs mounted directly onto the building above the level of the verandah or awning
Flashing signs	Illuminated at frequent intervals by an internal source of light (does not include variable message boards)
Novelty signs	Odd shape signs often three dimensional incorporating items such as cars, wine barrels, “big” product samples etc. generally will not be permitted in business or residential and rural zones.
Vehicle signs	Cars, trailers or equipment bearing advertising material do not make a positive contribution to the area and should not be parked for the express purpose of advertising or providing direction to a business

Signage in heritage areas

Signage in heritage Conservation Area is to:

- Enhance the character of the street scape
- Integrate with the design of the existing buildings
- Use existing or original locations or fixing points
- Is designed in styles that enhance the character of historic buildings
- General design controls for signage are recommended in the Baradine Heritage Main Street Study February 2014
- Refer also to Heritage Signage Controls Chapter 5.

Signage in business areas

- Generally, a maximum signage area per commercial building (regardless on number of tenancies) of 25% of the frontage is permitted per building
- Under awning/verandah signs must have a minimum height of 2.6 metres distance from the pavement to the bottom of the sign and protrude no further than a maximum length of 3.5 metres as measured from the front wall of the commercial building and will not protrude beyond the line of the awning/verandah
- Additional pylon signs, projecting wall signs, above awning signs, illuminated wall signs located above the verandah or awning and roof signs are not permitted in business areas
- Wall signs should be either painted directly onto the building or constructed of painted wood, or coated at point of manufacture or powder coated flat metal sheets. Wall signs utilizing plastic or modern metal materials are not favoured. Specific consideration should be given to buildings that are Heritage Items or within a Heritage Conservation Area. In those instances it is recommended that you discuss your proposal with Council’s Development Services or Heritage Advisor prior to finalizing the design.
- Refer to Diagram 11 Displaying of Signage for acceptable signage locations.

Diagram 5 Displaying of Signs

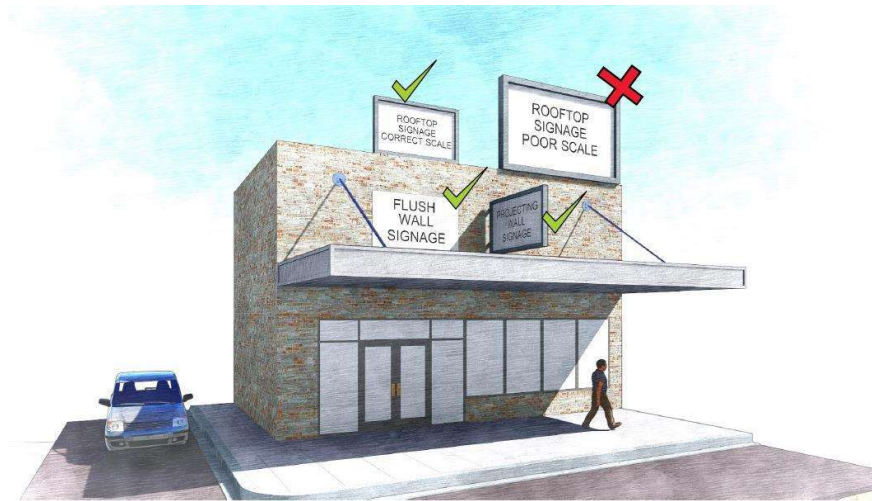

Signage in industrial areas

- Non-illuminated pole/pylon signs and directory boards shall be limited to a maximum of 6m² advertising area and a maximum overall height of 5 metres. In general, the bottom of a pole or pylon signs should be at least 2.6 metres above ground level.
- Illuminated pole or pylon signs must have a maximum area of 4m² and must abide by the Dark Sky Planning Guidelines approved by Siding Springs Observatory.
- A maximum of one pole or pylon sign can be erected without Council approval if the above requirements are met
- A maximum of two (1) pole or pylon signs shall be permitted per site frontage
- In the case of an industrial multi unit complex, one (1) directory sign board of up to 8m² in any area may be permitted with approval. Each industrial unit may have a sign at the entrance of each unit having the maximum dimensions of 2000mm by 600mm without approval
- One sandwich board sign per site is permitted without approval however must be located inside the property boundaries and weighted and securely fixed so that it will not blow over. A maximum area of 2m² per site applies
- Council will not approve the use of flashing lights, bunting and other devices to attract attention to a business

Signage in residential areas

There are a number of businesses outside traditional shopping centres and industrial estate as well as many home industries. Businesses in residential areas must have special controls to maintain the residential amenity of the neighbourhood.

The following criteria must be met for *building identification signs* or *business identification signs* in residential areas:

- The sign shall only display the name and nature of the business, including address, hours of business, telephone number and the like
- The sign shall not be larger than 1m long and 300mm high or similar proportions
- The sign shall not be erected higher than 1m above ground level
- The above provisions apply to signage on the building or site of the business. Advertising signage on other land will not be permitted
- Council will not approve the use of flashing lights, bunting and other devices to attract attention to a business
- Any other signs to be erected on a property shall be considered in accordance with

- the type of business and whether there are any “existing-use” rights for signage
- Generally, only one sign will be allowed for home industries, home occupations and home businesses

Signage in rural areas

The following criteria must be met for businesses in rural areas and includes signs relating to Landcare and Community Projects:

- Advertising signs must describe premises and be located on private land, not in the road reserve
- Maximum of one sign only per site
- Maximum height of 3 metres
- Maximum area 3m²
- Made of non-reflective material
- Must be free standing post sign
- Must be set back 3 metres if located on a corner or intersection of a road,
- Not be illuminated

Tourist signage Identification signs

These are post supported or wall structures located at the front of the site with the express purpose of identifying the business or facility to the travelling public.

- Post supported structures maximum height of 3 metres above ground level or an advertising area of not more than 3m² with typical dimensions being 1.2m x 2.5m,
- Identification signs must relate to a lawful or approved use of the land and be located on private land, not in the road reserve,
- The size, colour and shape of the signs will general be left to the discretion of the business but should not include the use of bright or fluorescent colours or highly reflective or illuminated materials,
- Each property shall be allowed two two identification signs (which may be double sided). In circumstances when the property has two road frontages Council will consider a third sign on the secondary frontage where that frontage has a minimum of 250 metres,
- In circumstances where there are two or more businesses operating from a site, Council will consider increasing the maximum sign face area from 3m² to 4m².

Maintenance and illegal signs

- Signage is reflection on the community as a whole. Council will not tolerate amateurish and poor quality signage
- A person intending to erect a sign should refer to a qualified sign writer for advice in relation to size, colour, location and design
- Unprofessional signs will be resisted. In circumstances where, in the opinion of Council, signs become unsightly or unsafe, Council will require the removal, repair or replacement as appropriate under the particular circumstances
- In circumstances where signs have been erected without prior approval of Council, a notice will be issued requesting the landowner to remove the subject sign
- Signs that have been erected or placed on public land or within a road reserve without the approval of Council will be impounded without notice and administrative fees levied for their release. After 3 months signs may be sold to offset Council's costs

Temporary signage

- Temporary signage for the purpose of advertising a major or charitable event is permitted to be erected on any land (with the owner's consent) for a period of one (1) week prior to the event
- This type of signage may include Variable Message Boards which may require

Roads and Maritime Services concurrence

- This does not permit local businesses advertising particular sales or the like
- Only one sign is permitted per event (multiple signs around a town are not permitted)

Heritage Conservation

These provisions apply to all zones under WLEP 2103

The purpose of this section is to provide guidance about development within Heritage Conservation Areas or on Heritage Items. Heritage Conservation Areas and Heritage Items are listed in the Warrumbungle LEP 2013 and their locations are recorded on the associated heritage maps. The Warrumbungle LEP 2013 also states requirements for development in heritage areas or on heritage items.

Where this Section applies

This chapter applies to all land identified in the Warrumbungle LEP 2013 and associated maps as having Heritage significance. Individual buildings and sites are listed in Schedule 5 of Warrumbungle LEP 2013. There are (6) six Heritage Conservation Areas referred to as:

- Baradine
- Binnaway
- Coolah
- Coonabarabran
- Dunedoo
- Mendooran

Conservation

The historic character of the six Heritage Conservation Zones should be appropriately conserved and enhanced by:

- Preserving individual buildings of significance
- Preserving intact early building components on all existing buildings (including windows shopfronts, awning supports, verandahs and historic signage) and repairing/restoring them as necessary
- Ensuring new development complements the existing character of each town

Missing components or decorative detail on historic buildings should be reinstated as part of any refurbishment work or repair. This includes reinstating verandahs in accordance with known previous designs identified in historic photographs.

Alterations to existing historical facades (above awning level) should not be permitted where the façade is part of a homogeneous or symmetrical group. If previously painted these building groups should be painted in uniform colour schemes. Unpainted face brickwork should not be painted.

Original façade elements (above awning level) such as parapets and ornamental detailing should be retained. Where it can be ascertained that known detail has been removed this should be reinstated where possible.

Development within the Heritage Conservation Zones should not be permitted to exceed the height of existing parapets.

Building height and alignment

Permissible heights (maximum and minimum) should be related to the prevailing height of existing buildings.

Consistency of building alignment is one of the major characteristics of traditional town centre development. New developments and additions to existing structures should match the street alignment of adjoining buildings.

Corner buildings should be generally built to the street-front alignment and no further back

than adjoining buildings.

Building form

The form of any new development (including additions to existing buildings) should seek to relate appropriately to its context while maintaining its own particular architectural character. Existing building forms found throughout the area are relatively simple in character, with roof or parapet elements and façade detailing used to give visual interest. It is encouraged that new developments should follow established forms.

No painting of Heritage listed buildings or buildings within the Heritage Conservation areas is permitted without prior written Council consent.

Roofs

A number of recommendations are made in relation to roofs:

- **Form, pitch and eaves height** - The form, pitch and eaves/gutter (or parapet) height of new roofs should sympathetically relate to adjacent buildings. Roofs that are not visible from adjacent or public areas may vary from existing forms. Typical roof forms used in the Warrumbungle Shire include gable, hipped and skillion roofs.
- **Parapets** - Parapets should be used where appropriate to the existing context. Parapets on new buildings should be designed to reflect the general character of surrounding buildings.
- **Roof cladding materials** - Cladding materials for new roofs should match or sympathetically relate to adjacent buildings. Recommended materials include:
 - Corrugated steel. This can be either clear galvanised iron or clear zincalume. Colorbond colours should be restricted to light or mid grey. Red Colorbond can be used on hipped roofs where it can be demonstrated that a red finish was used previously. Existing corrugated galvanised iron roofs may be painted with silver or grey finishes.
 - Terracotta tilesSquare profile steel decking and coloured cement roof tiles should not be used on roofs visible to street frontages and public areas.

Facades

Facades of new buildings, or additions to existing structures, should seek to relate to the form and character of surrounding buildings. Alterations to existing buildings should seek to match the detailing of the original structure. Details to be considered include the following:

- **Proportion** - The position, proportional spacing and visual impact of major vertical and horizontal elements, including blade/party walls, attached piers, changes on the line of the façade, string courses and cornices, eaves and rooflines, should seek to match or otherwise relate sympathetically to nearby buildings.
- **Windows and doors** – The size, proportion and placement of windows and doors should relate both to the size and architectural character of the new building and its immediate context.
- **Materials** – Building materials for new structures should relate sympathetically to adjoining buildings. Building facades should be constructed as follows:
 - Rendered or painted masonry, including brick or reinforced concrete,
 - Face brickwork compatible with the finishes and toning of historical brickwork,
 - Timber-framed parapet clad in flat panelling such as Hardiboard.Ribbed metal cladding, perforated screens or other similar sheet cladding should be avoided.

- **Ornamentation** – Surface ornamentation on historical facades should be restored if damaged or missing. This includes existing tiling to the front wall of shops below awning height. Subtle surface decoration may be used on new buildings to break up blank facades and relate to neighbouring structures.
- **Shop blinds** – External canvas blinds should be retained. If replacements are required these should reflect historical colour, materials and pattern.
- **Shop-fronts** – Original or early shop-fronts should be conserved where possible. Significant features such as windows, framing, tiled entrances, shop-front tiling, doors etc. should be repaired or restored as necessary. Existing shop-fronts should not be bricked up or fitted with roller shutters.

Verandahs

Many commercial buildings within the Warrumbungle Shire were constructed with footpath verandahs or bracketed awnings, which have since been removed. Reconstruction of demolished verandahs in accordance with historic photographs would enhance the character of the affected buildings and their surroundings.

Reconstructed verandahs should be designed to reflect known verandahs styles identified in historic photographs.

Many Art Deco and Post-War buildings were constructed with cantilever awnings. Construction of verandahs on the fronts of these buildings is not considered appropriate.

The facades of a number of Edwardian buildings were heavily remodelled during the Inter-War period. Erection of verandahs on the faces of these buildings is not considered appropriate.

Signage

Commercial, building and advertising signage is one of the most significant features of retail precincts. The use of appropriate forms of signage can add substantially to the character of an area. Inappropriate or poorly used signage can severely detract from the visual amenity of a retail area.

Where a retail precinct has a strong historical and/or architectural character the use of appropriate signage can be crucial in reinforcing character and visual amenity. Generally, signage should be designed to enhance the architectural and visual qualities of the place by:

- Being in scale with the buildings to which it is fixed,
- Being placed in a way that does not obscure attractive architectural elements and detailing,
- Using colours, fonts and styles that enhance the character of the area.

It is also important to recognise that the principal aim of signage is to attract customers, advertise goods and differentiate between businesses. Well designed signage can achieve these outcomes and enhance the character of a retail area.

Corporate or franchise signage can create particular issues for historical retail precincts. Councils in many areas are negotiating outcomes in relation to corporate signage which ensure that these signs enhance the character of these precincts. The publication *Streetwise – A Practical Guide* contains practical examples of the sympathetic use of corporate and franchise signage.

Proposed signage controls

The following controls ensure that commercial, building and advertising signage:

- Enhances the character of the streetscape,
- Integrates with the design of existing buildings,
- Uses existing or original locations or fixing points,
- Is designed in styles that enhance the character of historic buildings.

To achieve this, the following general design controls are recommended:

- **Scale** – The size and format of signs should generally be related to the buildings to which they are attached. In the case of buildings that contribute to the character of the precinct in which they are located the size and format of signs should be governed by the size appropriate to their type and location. In determining this consideration should be given to the size of awning fascia, panels in parapets etc.
- **Location & type** – Signs should be designed to integrate with and complement rather than obscure the architectural character of building facades
- **Signs located in the place of the main façade** – Signboards should be designed to fit within the “frame” provided by the elements of the building façade to which they are fixed. Historic photographs may provide examples of the traditional placement of signage on building facades
- **Awning, verandah and fascia signs** – Generally signage fixed to these building elements should fit within exposed faces. It is recommended that awning signs should be painted in situ and applied to exposed fascia only
- **Above awning and verandah signs** – Above awning and verandah signs may only be used if they are;
 - Appropriately scaled and detailed to complement the building to which they are affixed and they
 - Reconstruct the form of a known historical sign originally fixed to the awning or verandah.
- **Plaques** – Plaques identifying the premises of professional or commercial practices should be designed to fit within the building element to which they are being attached e.g. a door, door surround or building pilaster.

Flood Prone Land

These provisions apply to all flood affected lands

This section applies to land use and development on flood prone land within the Shire. For the purposes of this section “flood prone land” is defined as land identified as the “flood planning area” on the Flood Prone Map associated with Warrumbungle Shire Council LEP 2013.

Limited flood studies have also been undertaken by the former NSW Department of Water Resources in June 1987 for the villages of Mendooran and Coolah.

A more recent detailed flood study titled *Teridgerie Creek at Baradine Floodplain Risk Management Study and Plan* prepared by Lyall & Associates was completed for Baradine township March 2012. The subsequently adapted *Baradine Flood Policy 2012* will need to be addressed when assessing development applications in flood affected areas in Baradine. The provisions of Clause 6.2 *Flood Planning*, WLEP 2013 will also need to be read in conjunction with the *Baradine Flood Policy* controls.

Copies of the above mentioned studies are available from Councils Environment and Development Services on request for a fee.

Outside of the “flood planning area” and the above mentioned study areas the extent of flooding is not known and consequently Council will use its discretion in applying this section of the DCP to land considered to be potentially within the 1 in 100 year ARI or 1% AEP flood level.

This section should be read in conjunction with the requirements of Section 6.2 of the LEP. The Flood Planning Level (FPL) under the LEP means the level of a 1 in 100 ARI flood event plus 0.5 metre freeboard.

Objectives

The objectives of this section are to:

- Provide detailed controls and criteria for the assessment of development applications on land effected by flooding in Warrumbungle Shire Council
- Consolidate existing flood planning principles and policies from relevant government agencies into a coherent framework for application at the development control level by Warrumbungle Shire Council
- Reduce the impact of flooding and flood liability on individual property owners and occupiers
- Reduce private and public losses resulting from flooding
- Restrict the intensification of development below the Flood Planning Level (FPL)
- Limit development below the FPL to those activities and works considered to have an essential relationship with the river and its floodplain
- Provide specific measures for the control of caravan parks and associated development types within flood affected areas
- Provide for the consideration for the cumulative effects of any development on flood affected land, which in or of itself may be considered to be insignificant
- Provide for and protect the natural passage, storage and flow of flood waters
- Recognize and help sustain the natural ecosystems of floodplains and riparian zones including the protection of associated vegetation and wetlands
- Inform the community as to the extent and hazard of flood affected land in Warrumbungle Shire Council
- Deal consistently with application for development on flood affected land, generally in accordance with the Floodplain Management Manual: The Management of Flood

Liability Land issued by the New South Wales Government 2005

- Encourage the development and use of land which is compatible with the indicated flood hazard

Decision guidelines

Proposed developments will be considered on their merits in terms of flooding impacts.

Issues to be taken into consideration regarding the particular merits of development on flood liable land include the following:

- Whether the proposed development is reasonable having regard for the flood risk and resources available to the location. Applicants should place no reliance on the implementation of a condition specifying a private evacuation/flood management plan as a means to overcome an unacceptable flood risk
- The pollution threat represented by any development in the event of a flood
- The cumulative effect of the proposed development on the behaviour of floodwater
- The cost of providing emergency services and replacing infrastructure in the event of a flood
- The NSW Government Floodplain Development Manual – *the Management of Flood Liable Land (2005)*
- Council requires a flood investigation report where land is identified within the “flood planning area”. The flood investigation report will determine the level of flood category over the land identified in Table 9.

Flood Planning Area

For the purposes of applying development controls in this DCP to the “flood planning area”, two hydraulic categories of flood prone land (*flood storage and floodway*) and two hazard categories (low and high) have been identified. In combination, these categories provide for four separate categories within which issues relating to land use and development in the flood planning area can be assessed. These categories are Low Hazard Flood Storage, High Hazard Flood Storage, Low Hazard Floodway and High Hazard Floodway. Refer to categories listed in Table 9.

A third hydraulic category *flood fringe* is the remaining area of land affected by flooding, after floodway and flood storage areas have been defined.

Habitable structures will require the floor level to be 500mm above the 1% AEP or 1 in 100 ARI flood where known or the highest known flood based on the *flood investigation report* (refer to definitions).

A safe and practicable flood evacuation path or means should be demonstrated with submission of the application. Refer to definition *flood Investigation Report* for survey/level requirements to demonstrate any safe evacuation means.

Table 10 summarises the flood characteristics within the hydraulic categories. The category which development will be assessed against will need to be determined at the development application stage, based on the results the *flood investigation report*. The report should identify the flood height and the hydraulic category i.e. flood storage level, floodway etc.

Development Outside the Flood Planning Areas

Council will use its discretion in determining whether land outside of the “flood planning area” to which a proposal related is within the 1 in 100 ARI or 1% AEP and therefore subject to the controls of this chapter of the DCP.

Council will utilise the State Government’s 2005 Floodplain Development Manual as a guide to determine the impacts of an extreme flood on development.

Land in rural areas which is potentially subject to flooding will require a separate *flood investigation report* to be submitted with a development application to determine the 1% AEP or 1 in 100 year (ARI) flood event for a particular development or the highest known flood. The floor level of any habitable structure is to be 500mm above the highest known flood or 1% AEP or 1 in 100 ARI where it is determined.

Table 8 Flood Definitions

Average Recurrent Interval (ARI) and Average Exceedance Probability (AEP)	Average Recurrent Interval (ARI) is defined as the average, or expected, value of the periods between exceedances of a given rainfall total accumulated over a given duration. It is implicit in this definition that the periods between the exceedances are generally random. An Annual Exceedance Probability (AEP) is defined as the probability expressed as a percentage that a given rainfall total accumulated over a given duration will be exceeded in any one year. A 1 in 100 ARI flood event is equivalent to a 1% AEP flood event.
Flood Planning Area (FPA)	Is the area to which planning controls relating to flooding apply (i.e. flood liable land). Shown on WLEP2013 - Flood Prone Maps.
Flood Planning Level (FPL)	The FPL is the level 500mm freeboard above a 1% ARI (Average Recurrent Interval)
Flood storage areas	Flood storage areas are those parts of the floodplain utilized for the temporary storage of floodwaters during the passage of a flood. Substantial reduction of the capacity of flood storage in an area may cause a significant redistribution of flood flows or increase peak discharge downstream
Floodway areas	Floodways are those areas where a significant volume of water flows during flood events and are often aligned with obvious natural channels. They are areas that, even if only partially blocked, would cause a significant increase in flood levels and/or a significant redistribution of flood flow, which may in turn adversely affect other areas. They are often, but not necessarily, areas with deeper flow or areas where higher velocities occur
Low Hazard	Low hazard refers to the depth and velocity of flood waters that if necessary, trucks could evacuate people and their possessions, able bodied adults would have little difficulty in wading to safety (depending on floodwater velocities). Water depths are generally less than 1.0 metre although can be higher
High Hazard	High hazard refers to the depth and velocity of flood waters where there is possible danger to personal safety, evacuation by trucks difficult, abled bodied adult would have difficulty in wading to safety (due to floodwater velocities), potential for significant structural damage to buildings. The depth of flood waters are generally 1.0 metre or more
Flood Fringe	Is the remaining area of land affected by flooding, after floodway and flood storage areas have been defined. Development would not have any significant effect on the pattern of flood flows and/or flood levels.

Table 9 Flood Categories and Development Requirements

	Flooding implications		General	Residential, commercial & industrial development	Caravan parks & tourist developments
Low Hazard Flood Storage	<p>a) Water depths are generally less than 1.0m. Depths can be higher.</p> <p>b) Should it be necessary, people and their possessions can be evacuated by trucks</p> <p>c) Able-bodied adults would have little difficulty in wading to safety (will depend on velocity of floodwater)</p> <p>d) Damage potential is low</p>	<p>a) The impact of new development on flood storage and therefore flood behaviour needs to be addressed</p> <p>b) Suitable for developments subject to evaluation of cumulative impact, except for some special use developments which by their nature are sensitive to flooding or where the use is especially necessary in times of flooding</p>	<p>a) No intensification of existing development will be permitted which is likely to cause a significant reduction in flood storage capacity or change in flood behaviour</p>	<p>a) Floor levels will be at least 500mm above 1% AEP or highest known flood. Any new habitable part of the structure below this level must be built of flood compatible materials.</p> <p>b) Non-habitable and minor additions may be permitted on flood liable land provided any part of the new building or structure below that level is built from flood compatible materials</p> <p>c) Proposed means of evacuation to be provided for all new habitable buildings.</p>	<p>a) Floor levels of any permanent structures/amenities will be at least 500mm above 1%AEP or highest known flood level.</p> <p>b) Access roads will not be built up more than 100mm above the natural ground level</p> <p>c) All services to the development shall be designed to withstand inundation and the force of floodwaters</p> <p>d) All services to the development shall be designed to be capable of being disengaged and sealed in times of flooding to prevent contamination of flood waters</p> <p>e) All applications shall be accompanied with a report from a suitably qualified engineer, demonstrating that all moveable dwellings can either be rapidly relocated to flood-free ground, or can withstand the force of flood waters without significantly affecting flood behaviours or river water quality</p> <p>f) Existing developments liable to flooding must have the ability to be evacuated at short notice in times of flooding. A flood emergency and evacuation plan will be required to be submitted with applications for new developments</p> <p>g) Existing development shall be required to implement a flood emergency and evacuation plan</p>
High	a) The depth of floodwaters can	a) The impact of new	a) No intensification of	a) Development shall be restricted	a) Special consideration should

Nature of flooding		Flooding implications		General		Residential, commercial & industrial development		Caravan parks & tourist developments	
Hazard Flood Storage	b)	generally be 1m or more low; in effect the floodwater forms a pond	developments on flood storage and flood behaviour needs to be addressed	development on land below the FPL will be permitted which is likely to place the owner or occupants (including their property) at risk from flooding or generate demand for emergency services or place others involved in evacuation at risk	to necessary rural dwelling houses and associated outbuildings	be given to caravan parks because:			
	c)	Evacuation of people and persons may be difficult and require boat or helicopter, often at some risk to the operators	Whilst new development is not generally considered appropriate in a high hazard area, it may be acceptable under certain conditions. Such conditions should be based on a detailed review of the impact of the development on flooding and the potential hazard to the proposed development	Where new development has potential to cause a significant reduction in flood storage capacity or change in flood behaviour, the proponent will need to demonstrate the proposal will not cause a significant increase in flood levels or flood hazard. Need to also provide adequate compensating works for flood storage, together with an engineering report to support the application.	Floor levels to be 500mm above 1% AEP or highest known flood. Any part of the dwelling which is non-habitable and below the flood level shall be constructed of non-compatible materials.	• They are often difficult to evacuate, a fact compounded by permanent vans, visitors lacking flood awareness			
	d)	There may be danger to personal safety		b)					
	e)	Social disruption and financial loss could be high		b)					
				c)					
				d)					
				e)					

Low Hazard Floodway	Nature of flooding	Flooding implications	General	Residential, commercial & industrial development	Caravan parks & tourist developments
<p>a) Water depths are generally less than 1m (can be higher)</p> <p>b) Should it be necessary, trucks can evacuate people and their possessions</p> <p>c) Aabled bodied adults would have little difficulty in wading to safety (will depend on floodwater velocities)</p> <p>d) Damage potential would be low</p>	<p>a) It is necessary to check the impact of new developments on the depth, velocity or distribution of floodwaters</p>	<ul style="list-style-type: none"> Time of day and weather conditions <p>a) No intensification of development will be permitted which is likely to place the owner or occupants (including their property) at risk from flooding or generate demand for emergency services and placing others involved in evacuation at risk</p> <p>b) Council may consult with relevant government agencies in determining whether a development proposal is likely, either independently or in combination with other similar developments, to cause a significant reduction in flood storage capacity or change in flood behaviour</p> <p>c) The developer or property owner should demonstrate that any building or structure could withstand the force of flowing floodwaters, including debris, buoyancy forces as appropriate. A detailed report from an appropriate consulting engineer is required to support a development application</p> <p>d) New development will not be supported within floodway areas</p> <p>e) Where new development is likely to cause a significant reduction in flood storage capacity or change in flood behaviour, proponent will need to demonstrate a proposal will not cause a significant increase in flood levels or flood hazard (including cumulatively with future similar developments)</p> <p>f) Need to also provide adequate compensating works for flood storage, together with engineering report to support</p>	<p>a) Commercial or industrial buildings are unsuitable for a low hazard floodway. Additions to existing buildings may be considered having regard to the provisions of this flood category.</p> <p>b) Dwelling houses must have a floor level at 500mm above 1% AEP or highest known flood. Any part of the new dwelling that is non-habitable below that floor level shall be constructed from flood compatible materials</p> <p>c) Non-habitable and minor additions may be permitted below the FPL provided any structure below that level is built form flood compatible materials</p> <p>d) Internal alterations, maintenance and minor repairs to existing structures are permitted</p> <p>e) Minor additions to existing dwellings will be considered on merit for each individual application</p> <p>f) Redevelopment of substantially damaged buildings by a flood event will only be permitted if the applicant is able to demonstrate that the proposed development will be reconstructed in a manner compatible with the flood risk</p> <p>g) Where a dwelling has previously existed on a property any replacement dwelling must have a similar building footprint. Additions/alterations to an existing building footprint must comply with appropriate conditions above</p>	<p>a) Special consideration should be given to caravan parks because:</p> <ul style="list-style-type: none"> They are often difficult to evacuate, a fact compounded by permanent vans and visitors lacking flood awareness Caravans are easily damaged Caravans can float away and obstruct bridge waterways or create other hazards <p>b) Primitive camping grounds will be considered provided that any permanent facilities associated with the provision of a water supply, toilet and refuse disposal are in keeping with the basic needs of the camping ground, and can be shown to withstand the force and duration of flooding, and will not adversely impact on river water quality under flood conditions</p> <p>c) No approval will be considered for any permanent facilities associated with caravan parks or tourist accommodation, including:</p> <ul style="list-style-type: none"> Permanent or non-flexible connection to services such as power, water and sewerage Permanent residency areas of caravan parks Relocatable homes (homes not being capable of being registered under the Traffic Act) The subdivision of lots for separate occupation sites Permanent flood control 	

Nature of flooding	Flooding implications	General	Residential, commercial & industrial development	Caravan parks & tourist developments
<p>High Hazard Floodway</p> <p>a) The depth and velocity of floodwaters are such that building could sustain major structural damage and in extreme cases, light frames houses could be washed away</p> <p>b) The depth of floodwaters are generally 1m or more</p> <p>c) There could be major difficulties and dangers in evacuating people and their possessions due to depth and floodwater velocities.</p> <p>d) There may be danger to</p>	<p>a) New development is generally not considered appropriate in a high hazard floodway</p> <p>b) The impact of any proposed development on the floodway and therefore on flood behaviour must be addressed</p>	<p>g) the application</p> <p>The feasibility of effective evacuation is to be demonstrated to Council including permanent, fail-safe measures to ensure the timely, orderly and safe evacuation of people from the area. It is also to be demonstrated that the displacement of these people will not significantly add to the overall cost and community disruption caused by the flood. Council may also consult the SES, and be provided by the proponent with a detailed engineering report to support the application.</p> <p>The difficulty of evacuating flood affected people may be because of:</p> <ul style="list-style-type: none"> • The number of people requiring assistance • Depth & velocity of floodwaters • Wading problems due uneven ground, fences and like • Mobility of people • Distance to flood free ground • Time of day and weather conditions 	<p>h) New buildings should be aligned to minimise impacts on the flow and/or passage of floodwaters</p>	<p>works</p>
<p>a) Primitive camping grounds will be considered provided that any permanent facilities associated with the provision of a water supply, toilet and refuse disposal are in keeping with the basic needs of the camping ground, and can be shown to withstand the force and duration of flooding, and will not adversely impact on river water quality under flood conditions</p> <p>b) No approval will be considered</p>	<p>a) New dwellings, commercial and industrial buildings are not suitable for high hazard floodway's</p> <p>b) Internal alterations maintenance and minor repairs to existing structures are permitted</p> <p>c) Major additions are not encouraged and applicants must comply with all conditions listed in general above</p> <p>d) Minor additions to existing dwellings will be considered on merit for each individual</p>	<p>a) No intensification of development will be permitted which is likely to place the owner or occupants and their property, at risk from flooding or generate demand for emergency services and placing others involved in evacuation at risk</p> <p>b) Council will consult with relevant government agencies in determining whether a development proposal is likely, either independently or in</p>	<p>a) New dwellings, commercial and industrial buildings are not suitable for high hazard floodway's</p> <p>b) Internal alterations maintenance and minor repairs to existing structures are permitted</p> <p>c) Major additions are not encouraged and applicants must comply with all conditions listed in general above</p> <p>d) Minor additions to existing dwellings will be considered on merit for each individual</p>	<p>a) Primitive camping grounds will be considered provided that any permanent facilities associated with the provision of a water supply, toilet and refuse disposal are in keeping with the basic needs of the camping ground, and can be shown to withstand the force and duration of flooding, and will not adversely impact on river water quality under flood conditions</p> <p>b) No approval will be considered</p>

Nature of flooding	Flooding implications	General	Residential, commercial & industrial development	Caravan parks & tourist developments
<p>personal safety. Social disruption and financial loss could be very high</p>		<p>combination with other similar developments, to cause a significant reduction in flood storage capacity or change in flood behaviour</p> <p>c) New development not suitable in high hazard floodways</p> <p>d) Where new development is likely to cause a significant reduction in flood storage capacity or change in flood behaviour, proponents will need to demonstrate proposal will not cause a significant increase in flood levels or flood hazard (including cumulatively with future similar development)</p> <p>e) Need to also provide adequate compensating works for flood storage, together with engineering report to support the application</p> <p>The feasibility of effective evacuation is to be demonstrated to the consent authority including permanent, fail-safe, measures to ensure that timely, orderly and safe evacuation of people from the area. It is also to be demonstrated that the displacement of these people will not significantly add to the overall cost and community disruption caused by the flood. Council may also consult the SES and be provided by the proponent with a detailed engineering report to support the application.</p> <p>The difficulty of evacuating flood affected people may be because of:</p> <ul style="list-style-type: none"> • The number of people requiring assistance • Depth & velocity of floodwaters 	<p>application</p> <p>e) Proposed buildings should be aligned to compliment the flow and/or passage of floodwaters</p> <p>f) Non-habitable additions and outbuildings are not permitted</p> <p>g) Redevelopment of substantially damaged buildings will only be permitted if the applicant is able to demonstrate that the proposed development will be reconstructed in a manner compatible with the flood risk</p> <p>h) Where a dwelling has previously existed on a property any replacement dwelling must have a similar building footprint. Additions/alterations to an existing building footprint must comply with appropriate conditions above</p>	<p>for any permanent facilities associated with caravan parks or tourist accommodation, including:</p> <ul style="list-style-type: none"> • Permanent or non-flexible connection to services such as water and sewerage • Permanent residency areas of caravan parks • Relocatable homes (homes not being capable of being registered under the Traffic Act) • The subdivision of lots for separate occupation sites • Permanent flood control works

- Wading problems due to uneven ground, fences and like
 - Mobility of people
 - Distance to flood free ground
 - Time of day and weather conditions
- f) The developer or property owner should demonstrate that any building or structure can withstand the force of flowing floodwaters, including debris and buoyancy forces as appropriate. A detailed report from an appropriate consulting structural engineer is required to support a development application.

Sex Services Premises (Brothels)

Location

- Council will not consider an application for a brothel within view or within a 100 metre radius of a church, hospital, school, community facility, residential zone or any other place regularly frequented by children for recreational activities or cultural activities
- An entrance to or exit from a brothel is not to be within 300 metres of the entry to any other approved brothel
- The interior of the premises is not to be visible from a public place
- Brothels shall not be located in a building that contains a dwelling(s)

Size and Layout

- An adequate reception/waiting room with a minimum area of 20m² is to be provided per premises
- The premises is to be located on an allotment with a minimum size of 900m²
- A brothel shall be restricted to a maximum of five (5) rooms where sexual services are provided at any one time
- The brothels appearance shall be discrete and sympathetic with adjoining premises

Car Parking

- Provision for 2 car parking spaces per room used for prostitution plus 1 space for any manager
- Disabled parking to be provided close to the building entrance in accordance with the AS2890.6 2009
- Car parking areas to be well lit

Signs

- Signs do not display words or images which are sexually explicit or otherwise sexually suggestive
- The sign identifies only the name of the person who conducts the business or the registered name of the business and be limited to 0.3m X 0.6m lit by a single globe
- A clearly visible street number must be displayed
- There is only one sign per premises
- The content, illumination, size and shape of the sign is well integrated and compatible with the building it is attached to

Security and Public Safety

- Development Applications are to provide details on measures to be undertaken to safeguard workers, clients and the general public. Such details are to address the number of hours of security personnel and the lighting of access ways and car parking areas.
- A private security company is to be engaged to monitor and regularly check entrances and exits.

General Requirements

- The hours of operation nominated with the development application form part of any approval and businesses will be bound by those hours unless a specific condition of consent is imposed by Council to the contrary.
- Should the specified operator change, Council must be notified prior to the business operating.
- If the number of sex workers, hours of operation or signage are proposed to be changed, it will be necessary to modify the consent or lodge a new application depending on the scale of the changes.

- Persons under the age of 18 years are not to be engage in the business or permitted on the premise.
- No alcohol to be provided or offered for sale.

Clause 6.7 Location of Sex Services Premises WLEP 2013

Consideration of these clause provisions is required to be addressed by Council in deciding whether to grant consent to the development

Limit on Development Consent

All development consents granted to a brothel application shall be initially limited to a period of 12 months. At the completion of this period, Council will re-evaluate the proposal in terms of any complaints received regarding the operation of the business, and in terms of compliance with conditions of consent.

If Council is satisfied that the brothel has operated in an orderly manner with minimal impact upon nearby uses, and in compliance with conditions of consent, it may approve a modification to the consent under the Section 96 of the Environmental Planning and Assessment Act 1979, to extend the consent.

Council may also impose conditions of consent relating to the hours of operations. This will also be subject of review after 12 month trial. If, after the 12 month trial, any hours of operation are shown to be causing a nuisance or disturbance in the neighbourhood, the approved hours of operation may be further restricted.

6. RURAL DEVELOPMENT CONTROLS

Applies to RU1 Primary Production Zones and R5 Large Lot Residential Zones

This section refers to dwellings, dual occupancy development, rural worker's dwellings, additions, tourist development and other forms of development permitted in RU1 Primary Production Zones and R5 Large Lot Residential Zones contained within Warrumbungle Local Environmental Plan 2013.

Objectives

- To provide design standards and guidelines for the appropriate siting of rural dwellings within the Warrumbungle Local Government Area.
- To protect the amenity of the locality in which the development is situated.
- To ensure that development preserves and complements any natural and/or cultural heritage characteristics of the area.
- To achieve well designed and sited dwellings and outbuildings that complements the landscape, and, in the opinion of Council, do not cause adverse visual impacts.
- To ensure that development does not adversely impact upon the existing and future agricultural and rural industry potential of the land and adjoining land.
- To ensure that development is located and designed having regard to bushfire, land instability and flooding risks/hazards.
- To ensure that satisfactory vehicular access is provided.
- To protect existing vegetation and corridors, minimizing possible impacts on threatened species, communities, populations or their habitat.
- Minimise potential pollution of rivers, streams and sub-surface waters.

Requirements

General Design Requirements

- Rural dwellings and dual occupancies are subject to the provisions of Clause 4.2A of the Warrumbungle Local Environmental Plan 2013.
- When building on lots which have frontages to unsealed roads consideration should be given to siting any buildings with regard to the potential impact that may be caused from dust arising from the road.
- Council may require the consolidation of undersized rural lots (vacant lots with an area of less than the minimum rural lot size) within the same property holding as a condition of consent for new rural dwellings. This will ensure the existing holding is not later fragmented to undermine rural productivity of the farm.
- Buildings and internal roads shall be sited so that they are not located or prominent ridgelines or knolls viewed from public places (roads, public spaces and the like) and should be sensitively placed within the rural landscape to minimise environmental impacts.

New buildings

- Rural buildings including garages and sheds should be clustered to form a group and where possible, buildings shall be broken into smaller elements rather than presenting a large building mass.
- All buildings should be setback at least 20 metres from the public road frontage in R5 Zone and 50m from the public road frontage in RU1 Zone. Greater setbacks should be considered for unsealed roads to minimise dust nuisance on residents.
- Materials and/or finishes should not give rise to visual intrusion by virtue of texture, colour or arrangement. The use of recessive earthy tones is encouraged.
- External materials must have low reflectivity if they are visible from a public road or neighbouring dwelling and there is a reasonable probability of glare affecting driver safety, residential amenity or the building being too visually intrusive.

- Development involving the on-site management of wastewater must comply with Council's On-site Sewage Management (OSSMS) requirements.
- Development within bushfire prone land must meet the relevant requirements of the Rural Fire Service and *Planning for Bushfire Protection 2019*.

Vehicle Access Requirements

Where access from a public road to a private property is required:

- All development is required to have legal and physical access from a public road to the development site. In this regard, Council may require evidence from a registered surveyor that this is the case.
- Access to a Classified Road requires the concurrence of Transport for NSW (TfNSW) and design and construction of the access to TfNSW standards at the applicants cost.
- Where a part of any access is via an unformed Crown road, Council will need to agree to the transfer the road in its ownership as roads authority. If agreed by Council the road will need to be constructed to Councils standards at the applicants cost. *Generally, the transfer of Crown roads in Council ownership as the roads authority is not supported by Council.*

Where Council does not accept transfer of the Crown road NSW Government the Land and Property Management Authority, Crown Lands (LPMA) will only consider allowing works on Crown roads where:

- *the works are minor and do not alter the natural terrain, and*
- *there is an existing track or road, and*
- *the road serves an existing development, or is required for access to Crown land or other public land, and*
- *no increase in intensity of use of property accessed by the road is proposed, and*
- *the cost of such works must be borne by the proponent, and*
- *works on a Crown road must be approved by LPMA.*

For advice on LPMA requirements contact NSW Trade & Investment, Crown Lands.

- Access via right-of-carriageway over adjoining private property must be registered on Certificate of Title.
- Road and drainage designs may need to be submitted to Council at the applicants expense prior to approval of any roadwork within a Council public road reserve.
- In areas identified as Bushfire Prone, access to the development must meet the current requirements of the Rural Fire Service (*Planning for Bushfire Protection 2006*).
- The proponent will be responsible for construction or upgrading of any vehicle access to the land. Driveway access is to be constructed with pipe culverts or concrete dish drains to comply with current engineering standards. Access layout shall comply with RMS Road Design Guide Figure 4.9.7 May 1999 (refer to Appendix B). The location of each driveway must be approved prior to any road works commencing. The number of accesses shall be limited to one per property/lot unless otherwise approved by Councils Director of Technical Services.

Environmental Considerations

- Development shall not be carried out on slopes greater than 15%. If development on slopes greater than 15% is unavoidable, the development shall relate to the slope of the land and measures shall be implemented to minimize erosion and visual impact. Council may require a geotechnical assessment to determine development suitability.
- *Clearing of vegetation in RU1 Primary Production, R5 Large Lot Residential, RE1 Public Recreation and RE2 Private Recreation Zones*– applications are to identify the area and number of trees to be cleared as part of the application. Clearing which does not form part of a Development Application to Council must be approved by the relevant Local Land Services Department. Routine agricultural management activities (RAMAS) cover a wide

range of day to day farming, safety and other activities where clearing of native vegetation does not require a property vegetation plan (PVP) under the Local Land Services Amendment Act 2016

- Clearing for purposes of RAMA does not require approval under the act. To find out what exemptions apply and the approval requirements for clearing of vegetation under the Act refer to the following website www.dpie.nsw.gov.au or www.environment.nsw.gov.au/vegetation/pvp
- Consideration shall be given to possible impacts on flora and fauna as part of the Development Application. Applicants may be required to address requirements of the Biodiversity Conservation Act 2016 through an appropriately qualified consultant report where a development may impact on any listed species.
- Riparian areas shall be protected with all associated development works being carried out at least 40 metres from the watercourse unless it can be proven that works will not have an adverse impact.
- Any new development should be located a minimum distance of 40m from any watercourse, with associated on site effluent disposal being 100m from the watercourse.

Bushfire Protection

All applications for development in Bushfire Prone areas (as identified on Council's GIS mapped Bushfire Prone Land) are to be accompanied by a bushfire risk assessment in compliance with the relevant requirements of the NSW Rural Fire Service. Reference is to be made to the requirements of Planning for Bushfire Protection 2019 produced by the NSW Rural Fire Service: www.rfs.nsw.gov.au

Applicants are encouraged to consult with NSW Rural Fire Service representatives for advice in the early stages of preparing their proposal.

Bushfire Protection requirements are listed in Chapter 5 Other Development Controls.

Flooding

In low-lying areas, a flood investigation report may be required to be submitted with a development application to determine appropriate floor levels for habitable structures.

Flooding requirements are listed in Chapter 5 Other Development Controls.

Land Use Separation

- Where a proposed development for a dwelling or other residential accommodation will adjoin an agricultural or rural enterprise on an adjoining property, the following buffers should be observed as shown in following Table 10:

Table 10 Land Use Separation

Land Use	Separation distance
Abattoirs	1000m
Spray/Cattle/sheep dip	500m
Animal feedlot (same site)	500m
Animal feedlot (other)	1000m
Extractive industry/mine where blasting involved	1000m
Extractive industry/mine where no blasting involved	500m
Intensive dairies (same site)	500m
Intensive dairies (other)	1000m

- Council may vary a buffer set back only where it can be demonstrated in writing by a proponent that a reduced setback will not cause any harmful effects on future residents by ensuring adequate protection measures exist or will be put in place to ameliorate any potential noise, odour or other impacts and that will also ensure the protection and the ongoing operation of the nearby rural industry.
- Any new residence or residential accommodation should be located a minimum distance of 2km from any active or proposed wind turbine, unless suitable measures are taken in the design and construction of the dwelling to ameliorate any noise or other impacts.

Effluent Disposal (Domestic)

- To ensure that land is suitable for on-site sewage management, and that on-site sewage management system are designed to operate sustainably, without resulting in environmental harm or risk to public health.
- Where an on-site sewage management system is proposed, an assessment report must be provided to determine land capacity for sewage effluent. The assessment must be carried out by an appropriate qualified consultant.
- On-site sewage management systems must not be located on sites where connection to reticulated sewer is available.
- Effluent disposal system is to comply with the requirements of A/S1547 and, the Environment and Health Protection Guidelines and, On Site Sewer Management for Single Households.
- Land that is described as Light Clay that is not strongly structured, Council's preferred sewage system is the installation of an Aerated Water Treatment System (AWTS)
- Surface irrigation areas must be made up of irrigation zones that have a minimum area of 250m², delineated and sign posted appropriately.
- Pump-out septic systems are only acceptable where on-site disposal of effluent is not feasible, and where access is available for a pump-out service to be rendered safely from a public road at the property boundary.
- On-site Sewer Management Systems (OSSMS) are to be designed and constructed to withstand known or likely flooding conditions which includes structural adequacy, avoidance of inundation and flushing or leaking of effluent into flowing flooded waters.
- With the installation of a OSSMS it is recommended that a grease trap is to be installed on the kitchen sink line to ensure efficiency of septic system and extend the life of the system
- On site systems buffer distances are specified in Chapter 4.

Electricity and Telecommunications Infrastructure

- Any structures associated with the provision of electricity and telecommunications to the development shall be sited to have minimal environmental impact including vegetation removed and visual impact.
- Applications are required to demonstrate the methods of power supply.
- Council supports the use of solar energy supplies.
- Where generators are proposed, controls shall be placed on the hours of operation and levels of noise emission having regard to the proximity of neighbouring development and the environment.

Water

- Rural buildings without a reticulated water supply shall have water storage tank(s) containing a minimum of 45,000 litres of potable water for domestic purposes.
- For fire fighting purposes a minimum of 20,000 litres (of the 45,000 litres referred to above or separate supply) is to be provided on site in a non-combustible water tank with a Storz fitting. The tank is to be designed and located to permit direct access by fire fighting personnel and vehicles.

Contamination

- Certain previous uses on a site can have effect on land that may make it unsuitable for rural housing (Chapter 5 Other Development Controls). These uses can include industrial operations, agriculture uses, stock dip sites, fuel and chemical storage areas. It is beneficial for an applicant to research the previous uses of the site to determine if any remediation works are required. The provisions of SEPP 55 (Remediation of Land) apply here. Council is unable to grant approval until the land is shown to be free of contaminants for the proposed use.

Fencing

- Solid masonry or solid panel fences are prohibited.
- Stock proof fencing is required to all public road frontages where the frontage is unfenced. No strainers or fence bracing shall extend onto or within the public road reserve.

Rural Workers Dwelling

- The dwelling is located within close proximity to the main dwelling and farm buildings precinct.
- The need for the workers dwelling is demonstrated by written justification with detailed breakdown of the duties of the rural worker and why the duties require a constant presence on site. Security alone is not a sufficient reason.
- Satisfying the provisions of Clause 4.2B WLEP 2013.

Second Hand (Relocated Dwellings)

These provisions apply to all residential and rural zones.

- Dwellings referred to as older, disused weatherboard or similar dwellings that have been partially dismantled, divided and are to be moved to a new site location
- Under no circumstances are such structures to be moved to their new site without first obtaining Council development consent and a Construction Certificate.
- The structure is also not to be temporarily stored elsewhere in the Shire without prior approval of Council
- The development application must include:
 - A comprehensive report prepared by a Structural Engineer certifying the soundness of the building; and
 - Photographic evidence of the dwelling (external and internal photographs)
 - A Hazardous Building material Survey prepared and/or certified by an accredited Occupational Hygienist/Asbestos Assessor certifying that either there is no asbestos or other hazardous material in the building, or it has been removed or it is safe/stable for transport and use of the building.
 - Site Plan
 - Elevations
- Any asbestos material must be removed from the building by an approved and licensed asbestos removalist and certificate of clearance issued prior to approval of the Construction Certificate.
- Council will require as a condition of approval that such structure be completed in a reasonable prescribed period of time and not left derelict on a site (i.e. 12 months). A security bond may be required by Council to ensure the building is upgraded within the time period specified by Council consent.
- The relocated structure should be in character, scale and comprise similar external material finishes to that of existing dwellings adjoining and, in the locality.
- Evidence of how the building will be transported to the site and a copy of any permit(s) to ensure safe passage of the dwelling in accordance with the relevant acts / legislation (eg Roads Act).
- Evidence of screening to obscure any elevated footings from public view, usually with a

sub-floor curtain around the base of the building.

Swimming Pools

- Are to be positioned, including fencing, behind the building setback or in the rear yard.
- Where visible from a public place or road, details of screening are to be supplied with the development application.
- The swimming pool water line must have a setback of at least 1m from a side or rear boundary
- A Geotechnical Report is required for the installation of an inground swimming pool.
- Any associated retaining walls or decks are not to exceed 600mm above natural surface level.
- Decking around a swimming pool must not be more than 600mm above ground level (existing). No raised decking is permitted between any aboveground swimming pool and any adjoining common dividing fence.
- Pool pump enclosure to be placed greater than 15 metres from a habitable room in a dwelling on adjoining property or within a sound-proof enclosure.
- Water from a swimming pool must be discharged in accordance with an approval under the Local Government Act 1993 if the lot is not connected to the sewer
- A child resistant barrier must be constructed or installed in accordance with the requirements of the Swimming Pools Act 1992. www.legislation.nsw.gov.au
- Compliance with all other requirements of the Swimming Pools Act 1992

7. RESIDENTIAL DEVELOPMENT CONTROLS

This chapter applies to all residential zones RU5 and R1 under the Warrumbungle LEP 2013 and Dwellings constructed in the B2 and B6 Zones.

Objectives

- Provide for a wider range of residential accommodation types to improve choice in living across the Shire;
- Encourage good design in residential development by providing and ensuring a comprehensive design orientated approach to new residential development;
- Set appropriate criteria for energy efficiency, privacy, noise, vehicular access, parking and open space; and
- Improve urban design and residential amenity in new housing developments.

Dwelling Houses and Ancillary Structures in RU5 Village and R1 General Residential Zone

Requirements

Building Height and Scale

The height of dwelling houses is not to exceed two storeys with maximum height 8.5m to the ridgeline from natural ground level. Refer to Diagram 6 .

Diagram 6 Building Height

Height of buildings

Example: Maximum height of building 8.5m

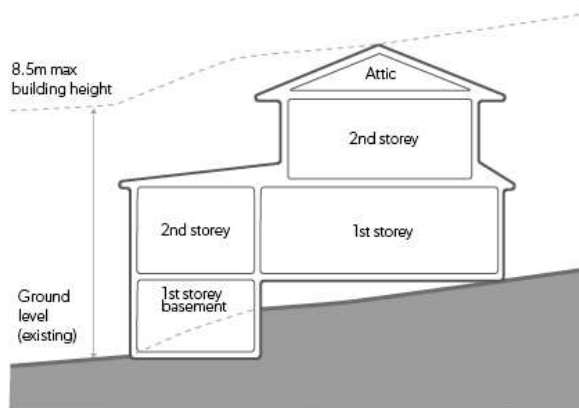

Picture: NW DPE

Front and Rear Building Setbacks

The setback of a dwelling house including attached/detached garage together with any ancillary buildings from the primary street frontage is to be a minimum of 6 metres. In established residential areas the setback will be consistent with neighbouring houses that share the same primary street frontage.

For a corner block, one of the street boundary setbacks may be reduced up to 3 metres to the building line.

The building lines of side boundaries are to be a minimum of 0.9m. The building line for a dwelling house to a rear boundary or rear laneway shall be at least 3 metres (does not include detached

ancillary structures).

Where a dwelling house has frontage to more than two (2) roads or laneways, the front, side and rear setbacks are to be assessed on merit having regard to the above standards..

Diagram 7 Building Setback

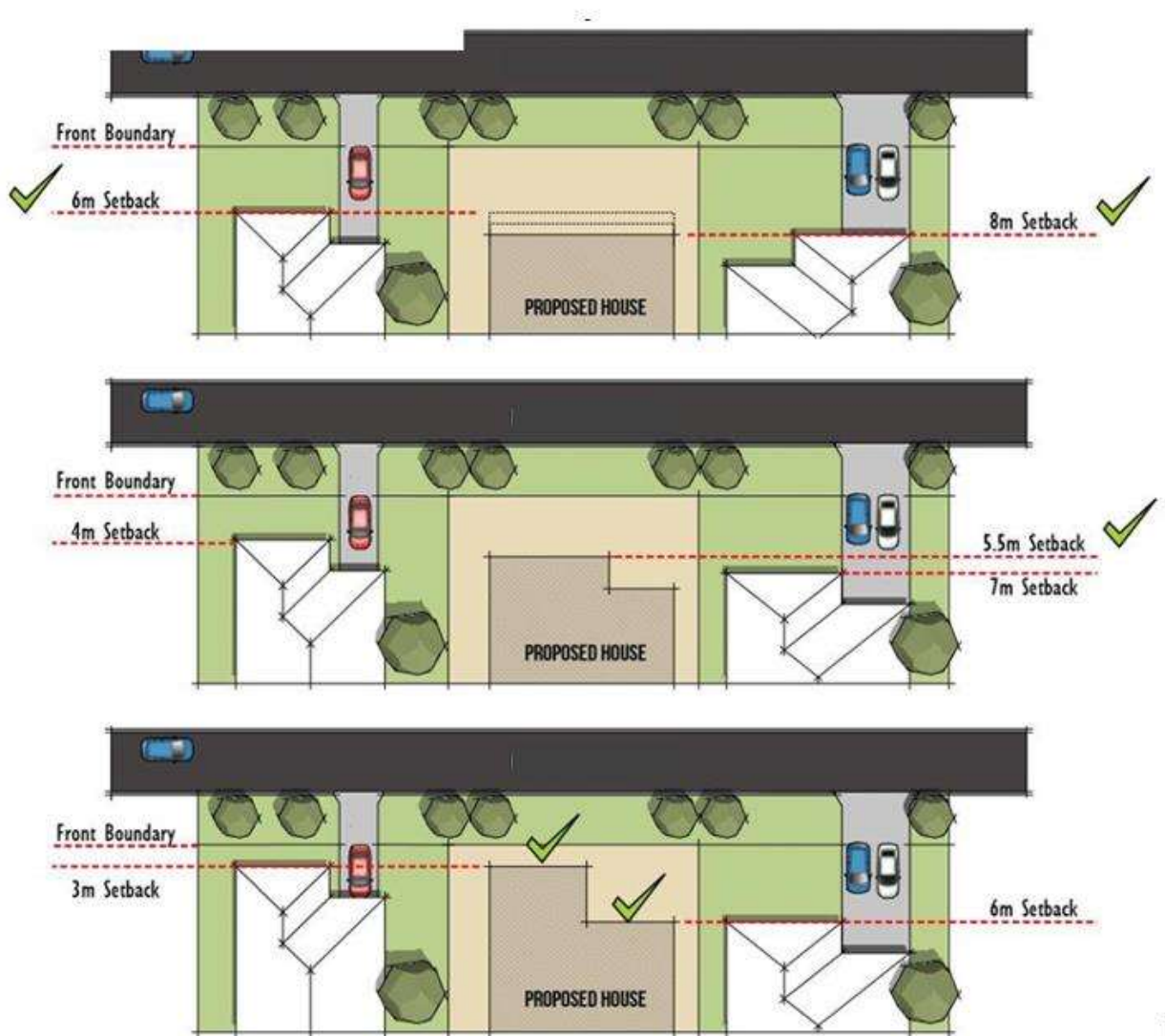

Articulation Zone within Front Building Set back

The “Articulation Zone” consists of architectural elements of the dwelling which address the street frontage. It may include elements such as an entry feature or portico, bay windows or similar features.

The encroaching element is measured from the minimum building set back of the lot, a 1.5m encroachment for 25% of the total width of the dwelling on the side at which the articulation zone is proposed.

Vehicle Access

- Where kerb and gutter is installed construction of a vehicle access crossing at the applicants expense is required over Councils verge in accordance with Councils Standard engineering drawing (refer to Appendix A).

- Where there is no kerb and gutter the vehicle access crossing is to be constructed of an all weather hard stand or bitumen surface between the bitumen road and property boundary.
- Vehicle access works must not divert road drainage into the dwelling site.

Car Parking

At least two (2) off-street car parking spaces are to be provided on the property behind the front building setback.

Outbuildings, Garages and Carports

- Carports and garages are not permitted to be located in front of the front building setback
- Garages and carports must be setback a minimum of 5.5 metres to ensure off street parking in the driveway in front of the garage or carport does not encroach on the footpath
- Maximum height of 4.8m between roof pitch and existing ground level
- Storage or car sheds should be located behind the dwelling house and be sited from the adjoining boundary so as not to cause loss of amenity from shadowing or visual impact to neighbouring properties
- Roof pitch should match the main building on site
- External cladding materials should be non-reflective and utilise colours that are not visually intrusive.
- The following size standards apply for outbuildings in R1 and RU5 Zones 10% of the block size to a maximum of 200m² ensuring that the maximum site coverage of 60% is not exceeded.
- The siting of the shed on the site will not interfere with the amenity of neighbouring properties by way of shadow, privacy or potential noise impacts, and
- The shed is not intended for any commercial or industrial type of activity.

Privacy

- Single storey development complying with setbacks do not require specific privacy controls
- Development of more than 1 storey should locate and size windows to habitable rooms to avoid facing onto windows, balconies or courtyards of adjoining dwellings.

Design

- No windowless facades at the street frontage(s)
- Street elevations are to include at least 50% of openings, including windows and doors
- Garage/s shall not exceed 60% of the street elevation.

Site Coverage

A maximum site coverage of 60% shall apply to dwellings and ancillary structures (refer to definition of site coverage)

Roof Pitches

A minimum roof pitch of 14degrees is required for the dwelling house or alternatively a skillion designed roof pitch of minimum 5 degrees may be incorporated in the architectural design of the building.

Retaining Walls

All retaining walls exceeding 600mm require Council consent and structural engineers details

Water Storage Tanks

All water tanks must be installed and located behind the front building set back.

Fencing

Fences within the front primary setback area to the building line are to be a maximum 1200mm high and be of open style for at least 20% of the area of the fence. Any front fences in excess of

1200mm will be assessed on merit having regard to the impact of the fence on the streetscape and the aesthetics of the proposed fence. *Refer also to State Environmental Planning Policy (Exempt and Complying Development Codes) 2008.*

Diagram 8 Front Fencing



Other side boundary fences are to be a maximum of 1.8 metres high behind the building line. Barbed/razor wire or electrified fencing in residential area is not permitted.

Solid front fences to main roads or highways for the purposes of noise attenuation and privacy are permitted to be a height of 1.8 metres however only where:

- The length of the fence does not exceed 5 metres without articulation or detailing to provide visual interest (refer to Diagram 7);
- The fence is constructed of materials which are consistent with those used in the development on the site and adjoining developments (other than solid metal panels or chain wire fencing);
- The proposed materials for construction have demonstrated capacity to attenuate noise;
- The appearance of the fence is softened with landscaping; and
- Any heritage considerations are satisfied.

Diagram 9 Solid Fencing



Swimming Pools

- Are to be positioned, including fencing, behind the building setback or in the rear yard.
- Where visible from a public place or road, details of screening are to be supplied with the development application.
- The swimming pool water line must have a setback of at least 1m from a side or rear boundary
- A Geotechnical Report is required for the installation of an inground swimming pool.
- Any associated retaining walls or decks are not to exceed 600mm above natural surface level.
- Decking around a swimming pool must not be more than 600mm above ground level (existing). No raised decking is permitted between any aboveground swimming pool and any adjoining common dividing fence.
- Pool pump enclosure to be placed greater than 15 metres from a habitable room in a dwelling on adjoining property or within a sound-proof enclosure.
- Water from a swimming pool must be discharged in accordance with an approval under the Local Government Act 1993 if the lot is not connected to the sewer
- A child resistant barrier must be constructed or installed in accordance with the requirements of the Swimming Pools Act 1992. www.legislation.nsw.gov.au
- Compliance with all other requirements of the Swimming Pools Act 1992

Services

- The dwelling house is connected to Council's reticulated water supply and sewerage system
- A Section 68 Local Government Approval is required for the connection of the dwelling to

Council services

- The development is to be connected to the relevant utility services including electricity, in accordance with the requirements of the relevant authority

Non Sewered Areas

- Where an existing allotment is non sewerer the lot size should be of sufficient area to accommodate an adequate sized on-site effluent disposal field area located behind or alongside the dwelling (not encouraged within the front building setback).
- There is adequate on site effluent disposal field area that allows a minimum buffer of 12m uphill, and 6m downhill of other property boundaries.
- For subsurface irrigation 6m uphill and 3m buffer downhill of property boundaries.
- Spray irrigation, surface drip and trickle irrigation disposal methods are not encouraged.
- Where the above setbacks cannot be achieved Council may vary the standards where a geotechnical report or similar consulting report can justify the variation.

Stormwater Drainage

- Stormwater shall be conveyed to Council's stormwater management system or otherwise to legal point of discharge.
- A Section 68 Local Government Approval is required for the connection of the dwelling to Council services
- Drainage from the development site is not to exceed drainage from the site in its pre-development state.

Water Tanks

- Located behind the street setback of the existing dwelling (unless placed below ground)
- Maximum height of 3.2 metres
- Suitably screened where visible from a public place or street.

Second Hand (Relocated Dwellings)

These provisions apply to all residential and rural zones.

- Dwellings referred to as older, disused weatherboard or similar dwellings that have been partially dismantled, divided and are to be moved to a new site location
- Under no circumstances are such structures to be moved to their new site without first obtaining Council development consent and a Construction Certificate.
- The structure is also not to be temporarily stored elsewhere in the Shire without prior approval of Council
- The development application must include:
 - A comprehensive report prepared by a Structural Engineer certifying the soundness of the building; and
 - Photographic evidence of the dwelling (external and internal photographs)
 - A Hazardous Building material Survey prepared and/or certified by an accredited Occupational Hygienist/Asbestos Assessor certifying that either there is no asbestos or other hazardous material in the building, or it has been removed or it is safe/stable for transport and use of the building.
 - Site Plan
 - Elevations
- Any asbestos material must be removed from the building by an approved and licensed asbestos removalist and certificate of clearance issued prior to approval of the Construction Certificate.
- Council will require as a condition of approval that such structure be completed in a reasonable prescribed period of time and not left derelict on a site (i.e. 12 months). A security bond may be required by Council to ensure the building is upgraded within the time period specified by Council consent.
- The relocated structure should be in character, scale and comprise similar external material

finishes to that of existing dwellings adjoining and, in the locality.

- Evidence of how the building will be transported to the site and a copy of any permit(s) to ensure safe passage of the dwelling in accordance with the relevant acts / legislation (eg Roads Act).
- Evidence of screening to obscure any elevated footings from public view, usually with a sub-floor curtain around the base of the building.

Manufactured Homes and Moveable Dwellings

- For requirements on installation of transportable houses refer to Chapter 5 .

State Environmental Planning Policy (Housing) 2021 **These provisions apply to RU5, R1 and R5 Zones**

- The State Environmental Planning Policy (Housing) 2021 has made the planning system simpler by consolidating 5 former housing-related policies into one policy.. The NSW Department of Planning and Environment has information on the different types of development that come under the [Housing SEPP](#).
- In designing a granny flat, or when deciding on the floor plan of a pre-fabricated granny flat, a range of matters should be considered including:

Appropriate location on the site: Granny flats should be positioned behind the primary building line and preferably at the rear of the existing dwelling.

Using appropriate and complementary building materials: External finishes should be selected to match the main dwelling. Shed conversions are generally not supported as their design makes compliance with BASIX difficult and their lesser aesthetic appearance is not desirable nor is it in the interest of the health and well-being of the occupants.

Ensure that the occupant's needs have been fully considered: Immediate and future anticipated needs of the occupants should be assessed, for example, wheelchair accessibility, bathroom design, heating and cooling systems, vehicle accessibility and the need for privacy.

Dual Occupancy and Multi-Dwelling Housing

These provisions apply to residential R1 and RU5 zones.

Requirements - Dual Occupancy

- The minimum lot size for dual occupancy is 700m² and minimum width of the lot is 18 metres at the front alignment of the building line.
- A dual occupancy located on a battle-axe lot must have a minimum access handle width of 6 metres
- The maximum site coverage for a dual occupancy in R1 General Residential and RU5 Village zones should not exceed 50% of the lot (refer to definitions).

Requirements - Multi-Dwelling Housing

- Multi-dwelling housing should be developed at the following density:

Dwelling Size	Density
Dwelling - 3 or more bedrooms	300m ²
Dwelling - 2 bedroom	215m ²
Dwelling - 1 bedroom	165m ²

Note: a 900m² lot size would allow 3x3 bedroom dwellings or 4x2 bedroom dwellings. One (1) bedroom dwellings should be no more than 50% of the total number of units

- Multi-dwelling housing buildings are not encouraged on battle axe lots
- Maximum site coverage of 40% (refer to definitions)

General Requirements for Dual Occupancy and Multi-Dwelling Housing

Building Height

- The development is not to exceed two (2) storeys in height with a maximum height of 8.5m to the roof ridgeline
- In the case of a dual occupancy proposed at the rear of a single storey dwelling house, the height should not exceed a 3.6m external wall height and roof ridgeline of 6m.

Detached Dual Occupancy

- Materials to be complimentary of the existing building and those in the locality
- Are not to give rise to adverse visual impact when viewed from adjoining properties

Roof Pitches

- A minimum roof pitch of 20 degrees is required or alternatively a skillion designed roof pitch of a minimum 5 degrees may be incorporated in the architectural design of the dual occupancy or multi dwelling housing building/s.

Setbacks to Boundaries

- The minimum front building setback for the development is six (6) metres. For a corner block, one of the street boundary setbacks may be reduced to 3 metres to the building
- In established residential areas (infill development) the front setback should be consistent with the established setback/building line of adjoining buildings (Refer to diagram 5)
- The side setbacks are three (3) metres for single storey development and 3.5 metres for two storey developments. The rear setback for all developments is to be 4 metres
- For corner lots, dwellings shall be designed to present to both street frontages

Articulation Zone within Front Building Set back

The “Articulation Zone” consists of architectural elements of the dual occupancy or multi dwelling housing which address the street frontage. It may include elements such as entry feature or portico, bay windows or similar features.

The encroaching element is measured from the minimum building set back of the lot, a 1.5m encroachment for 25% of the total width of the dwelling on the side at which the articulation zone is proposed

Car Parking

The following car parking requirements apply:

- One (1) covered car parking space for one (1) or two (2) bedroom dwellings
- Two (2) covered car parking spaces for each dwelling containing more than two (2) bedrooms, and
- One (1) visitor space per three (3) bedroom dwellings
- Stacked parking is not deemed to satisfy parking requirements (except for dual occupancy)
- All vehicular parking spaces, driveways and manoeuvring areas shall be sealed (bitumen, concrete or paving) in accordance with Council Technical Services Specifications
- Visitor car parking is to be clearly marked and accessible and be evident from street

Access

- Footway crossings to be constructed of concrete in accordance with Council’s kerb driveway crossing drawing
- Generally, the internal driveways and crossovers shall have a minimum clear trafficable width of 5.5m
- Driveways, manoeuvring areas and parking areas are to be designed in accordance with the provisions of AS 2890.1 Parking Facilities: Off Street Parking
- Long straight driveways are to be avoided

- Each resident car space to be a minimum dimension of 6m x 3m. other parking spaces are to have a minimum dimension of 5.5m x 2.6m
- All vehicles must enter and leave in a forward direction. Vehicles entering dual occupancy developments may be permitted to leave the site in a reverse direction if it can be demonstrated that it will not adversely affect traffic on the adjoining street. Stacked parking is permitted for dual occupancy developments

Footpaths

- Council may require construction of a reinforced concrete paved footpath fronting the development site

Carports and Garages

- Carports and garages will generally not be permitted to be located in front of the building line. Carports and garages should utilize similar design, colours and building materials as those of the dwelling
- The minimum setback for garage fronting a road is 5.5 metres

Solar Access

- Internal living areas and private open space should be located on the northern side of a development where practicable
- In winter (winter solstice 21st June) the windows of living areas and private open areas should receive not less than three hours of sunlight between 9am and 3pm. Sunlight to living areas and private open space of the dwellings on adjoining sites shall also receive not less than 3 hours of sunlight per day between 9am and 3pm. West facing walls shall be designed with few windows that are located, sized and shaded so as to reduce the ingress of summer sunlight and hot dry winds into living areas
- Shadow diagrams, for developments of 2 storeys will be required to demonstrate these requirements can be achieved

Street Design

- Front dwellings are to address the street frontage with windows and entries and that will provide casual surveillance
- Except in the case of dual occupancy garages should not face the street

Diagram 10 Street Frontage & Site Layout

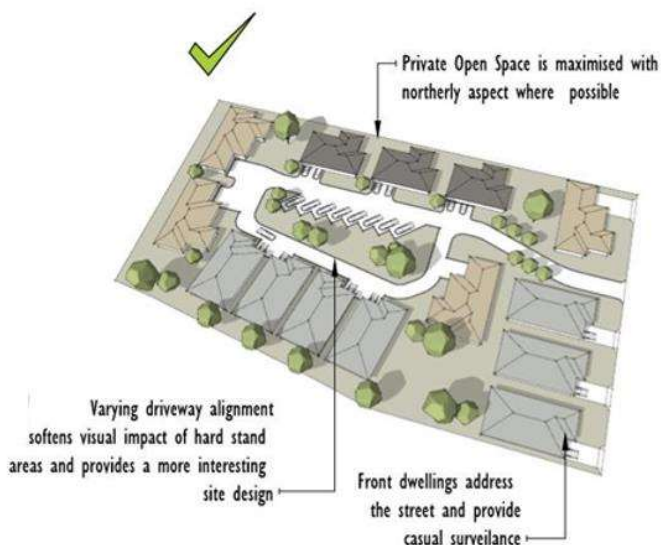

Privacy and Amenity

- Development of more than one storey must locate and size windows to habitable room (capable of occupation) to avoid facing onto windows, balconies or courtyards of adjoining dwellings.
- Habitable rooms overlooking the private open space of a neighbouring home are to have sill heights at least 1.7 metres above floor level or screening devices to avoid overlooking.
- A habitable room should look over the street to provide passive surveillance
- External lighting shall be baffled so there is no light spillage onto adjoining properties
- Windows shall be offset to increase privacy to adjoining buildings.

Private Open Space

- A minimum of 25m² of private, useable, open space is to be provided for each dwelling. The minimum dimensions for the private open space (POS) will be 4 metres minimum width
- Private open space (POS) shall be directly accessible from the main living areas of the dwelling. Where the dwelling is located above ground level, a balcony is to be provided having a minimum area of 10m² and width of 2 metres
- Private open space areas are not permitted in the building set back
- Private open space areas shall be provided with a mix of paved and landscaped area to provide areas of shade in summer and sunlight in winter together with a hard stand area for outdoor furniture
- A 1.8-metre-high fence is required between private open space areas of individual units

Landscaping

- Landscaped open must not be less than 30% of site area
- Appropriate vegetation should be used to provide shade to northerly and westerly elevations of buildings in summer, while allowing sunlight in winter. The provision of landscaping to the street frontage of new developments should attempt to enhance the appearance of the development and assist with streetscape integration
- A Landscape Plan should be prepared by an appropriate person (Landscape Designer or the like). The plan is to be drawn at a scale of 1:100 or 1: 200)
- Where common open space areas are provided, low maintenance gardens are preferred

Waste Management

- Screened garbage storage on a concrete pad is required onsite, inside the front property boundary, at rear of each unit or within garages. Details to be provided with the landscape plan.

Clothes Drying Facilities

- Each dwelling is to be provided with collapsible clothes drying line, or a mechanical dryer. The clothes drying area shall be suitably located and/or screened to ensure that the clothes line is not visible from any public street or area
- They may be installed in the POS area where they are of a collapsible design

Fencing

- Screen fencing will be provided where necessary to ensure adequate privacy, to open space areas.
- Where the existing side and rear boundary fences require replacement, the applicant is responsible for erecting a new 1.8m high timber paling or metal fence. (*i.e. colorbond*)

Letterboxes

- Separate letterboxes are to be provided for each dwelling in an accessible position, connected by a paved path. To be constructed in accordance with Australia Post requirements.

Adaptable Housing

- Developments of 5 or more units must provide 1 in 5 units capable of conversion to adaptable housing in accordance with AS4299 – 1995 Adaptable Housing
- Safe and accessible car parking spaces should be provided adjacent to continuous and accessible paths of travel to the dwelling.
- Designated disabled car parking must be allocated on site for use of residents to Australian Standard AS 2890.6 – 2009 Off Street Parking for People with Disabilities.

Stormwater Drainage

- Stormwater shall be conveyed to Councils stormwater management system or otherwise to a legal point of discharge
- Drainage from the development site is not to exceed drainage from the site in its pre-development state

Utilities and Services

- Buildings and structures are to be located clear of utility infrastructure
- For sewer mains, structures are to be located a minimum of one metre plus the equivalent invert depth from the centreline of the main.
- Servicing strategy required to demonstrate the availability and feasibility of providing water, sewer and stormwater services appropriate for the scale and nature of the development.

Non Sewered Areas

- Dual occupancy and multi dwelling housing are not encouraged in non sewered areas.

Containers

- The use of shipping containers requires consent unless they are exempt from approval under State Environmental Planning Policy (Exempt & Complying Development) 2008. These exemptions relate to:
 - o Some farm buildings (Subdivision 16 of the Code SEPP)
 - o Building site shed, office or associated structure (temporary) (Subdivision 3 of Division 3 of the Codes SEPP)
- In R1, R5 and RU5 zones containers are limited to one per property unless they are incorporated into an integrated structure that is architecturally acceptable to Council and the structure complies with other relevant provisions of this plan
- Where containers are to be incorporated into a building they will require pitched roof structures with non-reflective roof sheeting and external doors. The containers are to be painted in a colour consistent with other buildings and structures on the site.
- Containers are to be screened from a public place and any adjoining property. They must be screened from the street by suitable vegetation or other appropriate screening
- Containers are not sited within front or side setback distances (same as R1, R5 & RU5)
- Containers are free of major rust, are painted in a colour consistent with other developments on the site on land zoned R1, R5 & RU5
- Containers are placed on hard stand such as compacted gravel or the like
- Containers are not located over mains water, drainage or sewer lines or over an easement or effluent absorption area
- Any temporary installation is not to exceed 6 months and will require consent
- Setbacks to overhead power lines must comply with the requirements of the relevant electricity authority
- Containers must not be used for storing contaminated or hazardous materials
- Containers must not be stacked

8. COMMERCIAL DEVELOPMENT CONTROLS

These provisions apply to RU5 Village and B2 Local Centre zones

Objectives

- To reinforce the role of existing business precincts as the main focus for retail and commercial activity within the Shire
- To encourage the design of commercial developments to complement and conserve the existing streetscape character where there is an established character and to contribute towards the creation of a desirable streetscape image
- To provide guidelines for elements, such as the external appearance of buildings and landscaping, which contribute towards the preservation or establishment of a streetscape character
- To ensure that the design of developments provides ease of access for pedestrians, including people with disabilities
- To ensure that business development is served by the necessary physical infrastructure including reticulated water supply and sewerage and drainage systems
- To ensure that adequate vehicular access and parking is provided so as to protect the safety of other road users and provide for adequate onsite parking generated by additional demand

Building Setbacks

- No minimum setbacks are specified.
- Side and rear setbacks must meet BCA requirements

Height

- Height to conform to the existing height of adjoining and nearby commercial buildings and having regard to Council's heritage controls and the impact on the streetscape

Outdoor lighting

- Demonstrate compliance with *AS/NZS 11583.1 Pedestrian Area (Category P) Lighting and AS4282 Control of Obtrusive Effects of Outdoor Lighting*.
- Demonstrate compliance with Orana Regional Environmental Plan No 1- Siding Spring. Deemed State Environmental Plan (SEPP)

Outdoor Signage (Refer also to Outdoor Advertising Signage Chapter 5)

- A single business premises is permitted to have:
 - One under awning sign,
 - One top hamper sign, and
 - One fascia sign,That does not project above or beyond that to which it is attached. One of which may be illuminated, but not flashing, moving or floodlit
- Design and location of signage must be shown on plans with the DA.
- Where there is potential for light spill from signage to adjoining properties, all illuminated signage shall be fitted with a timer switch to dim or turn off the light by 11pm or close of business each night whichever is the earlier.
- Signage must comply with SEPP64 – Advertising and Signage Schedule 1 Assessment Criteria.

Design

- Building facades shall be articulated by use of colour, arrangement of elements or by varying materials including glazing. Use of reflective materials discouraged
- Large expansive blank walls are not permitted unless abutting a building on an adjoining allotment

- Awnings over the footpath should be designed to integrate with the architecture of the building façade and provide for continuous shelter for pedestrians. Awning should follow consistent heights above the footpath with a minimum height to underside of 3.2m
- Plans must show the location of all external infrastructure (including air conditioning units, plant rooms, ducting) and demonstrate how it will be screened from view from a public place or road
- Development on corner sites shall incorporate splays, curves, building entries and other architectural elements to reinforce the corner as land mark feature of the street
- Buildings should provide for an 'activated street frontage' by incorporating active uses at street level including cafes and other retail outlets
- Building entrances should be well defined
- The placement of windows should provide visual interest and variations to the building façade and relate to those of adjacent buildings
- The continuity of commercial frontages should not be broken by parking areas, service and delivery areas

Post supported verandahs and balconies

- Set back a minimum of 1m from the back of the kerb
- Must complement the style, materials and character of the building being altered
- Public liability insurance to Council requirements and a Council license is required for verandah or balcony awning over the public footpath
- Not to interfere with operation of or access to utility infrastructure

Utilities and Services

- Servicing strategy required to demonstrate the availability and feasibility of providing water, sewer and stormwater services appropriate for the scale and nature of development.
- Applications must demonstrate adequate provision for storage and handling of solid wastes.
- Liquid Trade Waste Application and facilities are required where liquid wastes (excluding domestic waste from a hand wash basin, shower, bath or toilet) are to be discharged to Council's sewerage system.
- Buildings and structures are to be located clear of utility infrastructure
- For sewer mains, structures are to be located a minimum of one metre plus the equivalent invert depth, whichever is greater, from the centreline of the main.

Traffic and Access

- The verge for the frontage of the development is to be constructed of hardstand materials to facilitate safe, low-maintenance pedestrian access. Details to accompany the development application.
- All vehicles must be able to exit the site in a forward direction
- Deliveries to and from laneway access where applicable
- Design must demonstrate no conflict between pedestrian, customer vehicles and delivery vehicles
- Sealed surfaces for access driveways, parking areas, loading/unloading facilities and associated vehicle manoeuvring areas relative to the design vehicle
- Unsealed vehicle movement areas are not acceptable due to environmental management impacts
- Loading bay(s) must be sited to avoid use for other purposes such as customer parking or materials storage and be line marked and signposted.
- Applicant to demonstrate adequacy of site access
- Separate, signposted entrance and exit driveways are required for developments requiring more than 50 parking spaces or where development generates a high turnover of traffic.

- The number of access points from a site to any one street frontage is limited to 1 ingress and 1 egress
- Driveways must be provided in accordance with AS2890.1 Parking Facilities

Parking

- Off-street parking is required in accordance with provisions outlined in Chapter 5

Access for Persons living with a Disability

Objectives

- To ensure that equitable access is provided to new commercial buildings and existing buildings undergoing a change of use or alterations and additions
- To ensure that developments comply with the provisions of the Disability (Access to Premises - Buildings) Standards 2010. Refer to Australian Building Codes Board web site www.abcb.gov.au for information on the standards and guidance on their implementation.

Controls

- New buildings or buildings undergoing alterations and additions or a change of use are required to provide equitable provision of access to and circulation within the premises for people living with a disability in accordance with the provisions of Disability (Access to Premises - Buildings) Standards 2010 (the Premises Standards).
- Continuous accessible paths of travel shall be provided:
 - From parking spaces, public streets and walkways to building entrance(s)
 - Between buildings, facilities and spaces that are on the same site
 - To connect the building entrance(s) with all spaces and facilities within the buildings and
 - To minimise travel distance between each accessible element of the building and of facilities within it
- For the purposes of the above access shall be provided to and within all the areas or facilities of the building where there is a reasonable expectation of access by any owner, occupier, employee, or visitor.
- Part D3.4 of the Access Code and BCA specify the areas that are not required to be accessible:
 - It does not include any area if access would be inappropriate because of the particular purpose for which the area is used, and
 - An area that would pose a health or safety risk for people living with a disability, and
 - Any path of travel providing access only to an area exempted by this clause.

Change of Use

Developers are encouraged to consult with Council's staff prior to undertaking a change of use of premises in order to determine which of the following planning pathways would apply:

- Development consent is not required for a change of use of premises that is exempt development under the Codes SEPP 2008. Although consent is not required for exempt development, it is still a requirement that Council is given written notification of the change of use.
- Change of use may also be permissible as complying development under the Codes SEPP. In this case, an application for a Complying Development Certificate will need to be lodged with Council.
- For a change of use of premises including food premises that does not fall into either of the above categories, a Development Application will need to be lodged with Council.

Heritage Considerations

- For Heritage provisions refer to Chapter 5.

9. INDUSTRIAL DEVELOPMENT CONTROLS

The following provisions apply to IN1 General Industrial Zones.

Objectives

- Focus the development of industries so as to minimise conflict between the different uses
- Direct different types of industrial development to locations best suited for that activity
- Provide a level of amenity in industrial areas for those that visit and work there
- Adequate parking for employees and visitors
- Ensure that development incorporates safe and functional movement of vehicles on and off site
- Ensure the implementation of landscaping for both screen and enhancement of industrial areas
- Ensure adequate utility services are provided

Requirements

Building Setbacks

- Primary street setback must be a minimum of 6 metres and 3 metres for secondary frontage
- No concession for secondary frontage
- Street setback must be landscaped
- A reduced landscaped primary street setback, to a minimum of 3 metres, is permitted where car parking is provided immediately behind the landscaped area
- Side and rear setbacks to meet BCA requirements

Design

- Building elevations to the street frontage or where visible from a public road, reserve, railway or adjoining residential area are to incorporate variations in façade treatments, roof lines and non-reflective environmentally sensitive building materials
- Low scale building elements such as display areas, offices, staff amenities are encouraged to be located at the front of the premises and constructed in either masonry or pre-painted steel cladding for example Colorbond or other similar materials
- Roofing materials should be non-reflective where the roof pitch is visible from a public road

Utilities and Services

- Servicing strategy required to demonstrate the availability and feasibility of providing water, sewer and stormwater services appropriate for the scale and nature of development
- Applications must demonstrate adequate provision for storage and handling of solid wastes
- Liquid Trade Waste Application and facilities are required where liquid wastes (excluding domestic waste from a hand wash basin, shower, bath or toilet) are to be discharged to Council's sewerage system
- Onsite stormwater capture and reuse is encouraged for maintenance of landscaping. Storage tanks shall be appropriately located and screened
- Buildings and structures are to be located clear of utility infrastructure
- For sewer mains, structures are to be located a minimum of one metre plus the equivalent invert depth from the centreline of the main
- Drainage from the development site is not to exceed drainage from the site in its pre-development state

Landscaping

- Landscaping is required to soften and enhance the visual appearance of the development:
 - In the front 6m of street setback
 - Side and rear setbacks where visible from a public place or adjoining residential area

- Areas adjacent to building entrances and customer access points
- Landscaping shall comprise only low maintenance, drought and frost tolerant species

Fencing

- Open work or storage areas visible from a public place or street must be fenced by masonry materials or pre-coloured metal cladding of minimum 2m height. Fencing to be located behind the building setback
- Security fencing must be also located behind the building setback area except when of a decorative nature to be integrated in the landscaped area

Access

- Applicant is to demonstrate the adequacy of:
 - Site access
 - Loading/unloading facilities
 - Safe on-site manoeuvring for largest design vehicle
 - Sealed surfaces for access driveways, parking areas, loading/unloading facilities and associated vehicle manoeuvring areas relative to the design vehicle
- Unsealed vehicle movement areas are not acceptable due to environmental management impacts
- All vehicles must be able to enter and exit the site in a forward direction
- Separate signposted entrance and exit driveways are required for developments requiring more than 50 parking spaces or where development generates a high turnover of traffic
- The number of access points from a site to any one street frontage is limited to 1 ingress and 1 egress
- Driveways must be provided in accordance with *AS2890.1 Parking Facilities* - the minimum width being 8 metres. May be reduced to 6 metres where considered appropriate having regard to the use

Parking

- Parking is to comply with relevant provisions of Chapter 9 Page 55.

Loading/Unloading Facilities

- Adequate space and facilities are required to be provided wholly within the site
- Loading and delivery bays must be designed to allow vehicles to enter and exit the site in a forward direction
- Loading bay(s) must be sited to avoid use for other purposes such as customer parking or materials storage and be line marked and signposted

Outdoor Signage

- Single occupant industrial site:
 - One free-standing advertisement within the 6m landscaped setback
 - One advertisement integrated within the façade of the building, but no higher than the building roof line
- Multiple unit industrial site
 - One index board near site entrance or within the 6m landscaped setback
 - One advertisement integrated within the façade of each unit, but no higher than the building roof line
- Signage must comply with *SEPP 64 – Advertising and Signage Schedule 1 Assessment Criteria*

Outdoor Lighting

- Must comply with AS4282 Control of Obtrusive Effects of Outdoor Lighting
- Demonstrate compliance with Orana Regional Environmental Plan No 1- Siding Spring. Deemed State Environmental Plan (SEPP)

Noise

- Windows, doors and other wall openings shall be arranged to minimize noise impacts on residences where proposed within 400m of a residential zone
- External plant (generators, air conditioning plant etc.) shall be enclosed to minimize noise nuisance where adjoining residential area

Industrial Development in RU5 Residential Village Zone

Any industrial development in RU5 Village Zone will be considered on its merit having regard to the development principles outlined above.

10. DEFINITIONS

This DCP adopts the terms and definitions of Warrumbungle LEP 2013 (WLEP2013). Additional terms used throughout this DCP are defined below.

adjoining land – land which abuts an application site or is separated from it only by a roadway, pathway, driveway or similar thoroughfare

AHD – Australian Height Datum

ancillary development – development on land for a purpose that is ancillary or incidental to a use under the WLEP2013

application site – the parcel of land to which a Development Application relates and includes all lands required for the carrying out of the application proposal

area – of an advertisement in the form of a sign means the area within the outline of that sign or, where one side is larger than the other, the area within the outline of the larger sign; or for any other sign (e.g. multi-sided signs), one third of the total surface area of the sign

asset protection zone (APZ) – is a buffer zone between a bush fire hazard and buildings, which is managed progressively to minimise fuel loads and reduce potential radiant heat levels, flame, ember and smoke attack

Code SEPP – *State Environmental Planning Policy (Exempt and Complying Development Codes) 2008*

contaminated land – land in, on or under which any substance is present at a concentration above the concentration at which the substance is normally present in, on or under (respectively) land in the same locality, being a presence that presents a risk of harm to human health or any other aspect of the environment

clearing (native vegetation) – Clearing is defined as cutting down, felling, thinning, logging, removing, killing, destroying, poisoning, ringbarking, uprooting or burning native vegetation. Refer to Native Vegetation Act 2003 www.legislation.nsw.gov.au

directional sign – a sign erected for purposes of directing vehicular or pedestrian traffic, advising or restricting the public

EP&A Act – the *Environmental Planning and Assessment Act 1979* (as amended)

flood investigation report – a report prepared by an appropriately qualified and experienced professional that reviews the history of flooding in an area, where modelling is not available. The review would draw upon historical information, including from landowners, physical evidence in the locality of any historical events, extrapolation (suitably qualified) from known information or events, and any other such information as might be considered by the professional to be relevant in estimating the flood height of the site.

The report should be accompanied with a survey plan prepared by registered surveyor showing existing ground levels, finished ground levels, finished floor levels, flood levels and location of existing and proposed buildings and any safe and practicable evacuation path from the site relative to AHD.

flood planning area – is the area of land below the flood planning level and is subject to flood related development controls. Shown with WLEP 2013 mapping.

flood planning level (FPL) – the level of a 1 in 100 ARI flood (1% AEP) event plus 0.5 metres freeboard

floodplain development manual – the NSW Government Floodplain Development Manual the management of flood liable land dated April 2005 as Gazette by the NSW Government on 6 May 2005, or any Gazette update of this

front building line – a line drawn parallel with the primary street frontage at the point of a building closest to the street. This line is expected to be no closer to the street frontage than specified for the primary street frontage setback except in the case of existing building setbacks. See Diagram 5. The setback should be no closer than 5.5m to the front boundary.

habitable room – refers to any room or area used for normal domestic activities, including living, dining, family, lounge, bedrooms, kitchen etc. but excludes services and amenity areas such as ensuite, bathroom, storerooms, laundry and garages

hazardous material – anything that, when produced, stored, moved, used or otherwise dealt with without adequate safeguards to prevent it from escaping, may cause injury or death or damage to life, property or the environment

integrated development – is development (not being Exempt or Complying) that, in order for it to be carried out, required development consent and one or more approvals set out in Clause 91 of the *Environmental Planning and Assessment Act 1979* (as amended)

land – includes any building or part building erected on the land

landscaped area – refers to any part of the site, at ground level, that is permeable and consists of soft landscaping, turf or planted areas, for the purpose of reducing stormwater run-off. It excludes driveways, parking areas, drying yards or other service areas, undercrofts, roofed areas, outdoor rooms, balconies, terraces, decks and verandahs

neighbouring land – means any land, other than adjoining land, which is near to a development site (and may include land in a neighbouring local Council area)

notification plan – the plan showing a site plan, height and external elevations of buildings, which accompanies a Development Application

owner –

- Every person who jointly or severally, whether at law or in equity, is entitled to the land for any estate of freehold in possession
- In the case of land that is the subject of a strata scheme under the *Strata Titles Act 1973*, or a leasehold strata scheme under the *Strata Titles (Leasehold) Act 1986*, the Owners' Corporation
- In the case of land that is community, precinct or neighbourhood parcel within the meaning of the *Community Land Development Act 1989*, the Association for the parcel

private open space – refers to the areas external to a building, located behind the front façade, that serve as an extension of the home and are used for private dining, entertaining and recreational purposes and includes terraces, balconies, alfresco areas etc.

remnant native vegetation – is any native vegetation other than regrowth. Regrowth means any native vegetation that has regrown since the earlier than 1 January 1990 in the case of other land,

or the date specified in a PVP (in exceptional circumstances being a date based on existing rotational farming practices)

residential development – dwellings, residential flat buildings, motels, boarding houses, hostels, caravan parks, units for the aged and any place where person would ordinarily be expected to reside and sleep

Site Coverage –

means the proportion of a site area covered by buildings and structures.

Site coverage is the proportion of a site that is covered by buildings and structures. Managing the total site coverage of dwelling houses and ancillary development stops residential sites from becoming too overdeveloped. It also ensures adequate space is provide for landscaping and private open space.

- a) site coverage includes the dwelling house and any of the following ancillary development:
- b) awnings,
- c) basements,
- d) detached studios,
- e) driveways,
- f) outbuildings,
- g) swimming pools, and
- h) any enclosed or unenclosed balconies, decks, patios, pergolas, terraces, verandahs, carports and garages that are attached to the dwelling house.

Statement of Environmental Effects (SEE) – is the record of the environmental assessment, which necessitates a process of identifying and discussing the planning and environmental information relevant to the site or proposal

WLEP2013 – means the Warrumbungle Local Environmental Plan 2013

Appendix B

RTA of NSW

Section 4 - Intersections at Grade
4.9 Median Cross-overs and Property Access

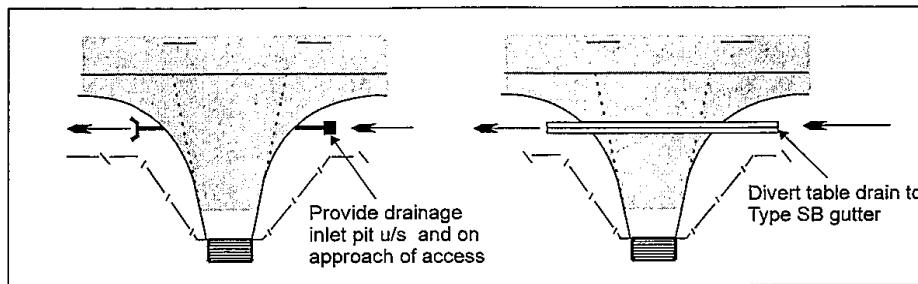

ALTERNATE TREATMENTS FOR TABLE DRAIN CROSSING

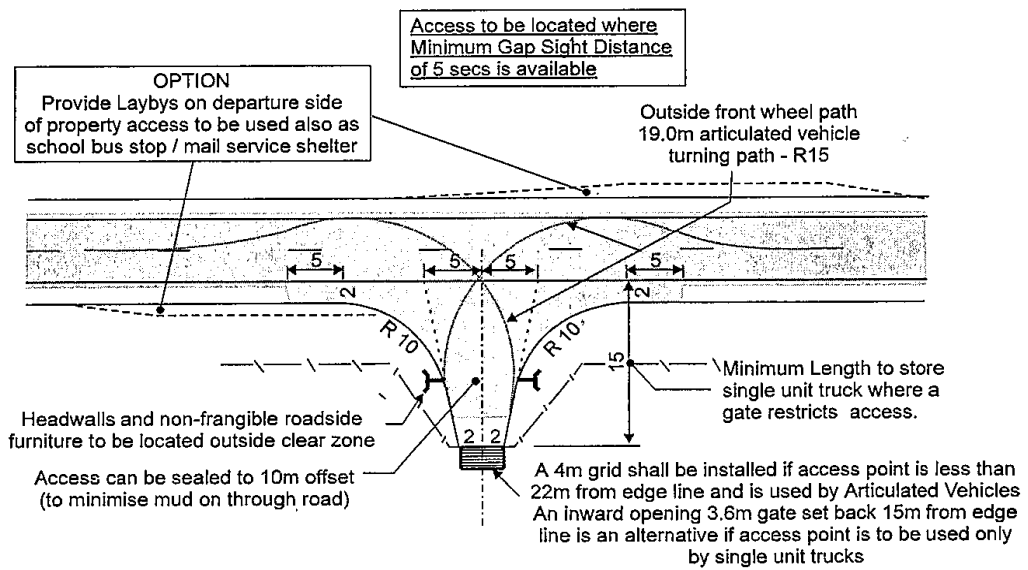

PREFERRED OPTION WITH INDENTED ACCESS
(showing single carriageway layout)

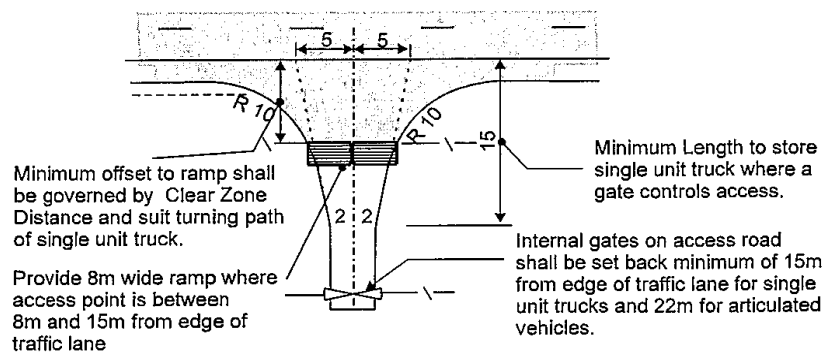

OPTION WITHOUT INDENTED ACCESS

Figure 4.9.7 - Rural Property Access - Layout 2(SU)
Single Carriageway - Design AADT < 2 000 - Minimum Requirement* OR
Dual carriageway "Left in - Left Out Access - Minimum Requirement for Single Unit Truck
(*where AADT > 1000 and access is a dedicated articulated vehicle access then use Layout 1(AV)



Warrumbungle Shire Council

Coonabarabran Administration Office

14-22 John Street
Coonabarabran NSW 2357

Phone: (02) 6849 2000

Mailing Address:

PO Box 191
Coonabarabran NSW 2357

Email: info@warrumbungle.nsw.gov.au

Coolah Administration Office

59 Binnia Street
Coolah NSW 2843

Phone: (02) 6378 5000